

# ***Aspire 5510***

## ***Service Guide***

Service guide files and updates are available on the ACER/CSD web; for more information, please refer to <http://csd.acer.com.tw>

---

## ***Revision History***

Please refer to the table below for the updates made on Aspire5510 service guide.

<b>Date</b>	<b>Chapter</b>	<b>Updates</b>

---

## ***Copyright***

Copyright © 2005 by Acer Incorporated. All rights reserved. No part of this publication may be reproduced, transmitted, transcribed, stored in a retrieval system, or translated into any language or computer language, in any form or by any means, electronic, mechanical, magnetic, optical, chemical, manual or otherwise, without the prior written permission of Acer Incorporated.

## ***Disclaimer***

The information in this guide is subject to change without notice.

Acer Incorporated makes no representations or warranties, either expressed or implied, with respect to the contents hereof and specifically disclaims any warranties of merchantability or fitness for any particular purpose. Any Acer Incorporated software described in this manual is sold or licensed "as is". Should the programs prove defective following their purchase, the buyer (and not Acer Incorporated, its distributor, or its dealer) assumes the entire cost of all necessary servicing, repair, and any incidental or consequential damages resulting from any defect in the software.

Acer is a registered trademark of Acer Corporation.

Intel is a registered trademark of Intel Corporation.

Pentium and Pentium II/III are trademarks of Intel Corporation.

Other brand and product names are trademarks and/or registered trademarks of their respective holders.

---

## ***Conventions***

The following conventions are used in this manual:

<b>SCREEN MESSAGES</b>	Denotes actual messages that appear on screen.
<b>NOTE</b>	Gives bits and pieces of additional information related to the current topic.
<b>WARNING</b>	Alerts you to any damage that might result from doing or not doing specific actions.
<b>CAUTION</b>	Gives precautionary measures to avoid possible hardware or software problems.
<b>IMPORTANT</b>	Reminds you to do specific actions relevant to the accomplishment of procedures.

---

## ***Preface***

Before using this information and the product it supports, please read the following general information.

1. This Service Guide provides you with all technical information relating to the BASIC CONFIGURATION decided for Acer's "global" product offering. To better fit local market requirements and enhance product competitiveness, your regional office MAY have decided to extend the functionality of a machine (e.g. add-on card, modem, or extra memory capability). These LOCALIZED FEATURES will NOT be covered in this generic service guide. In such cases, please contact your regional offices or the responsible personnel/channel to provide you with further technical details.
2. Please note WHEN ORDERING FRU PARTS, that you should check the most up-to-date information available on your regional web or channel. If, for whatever reason, a part number change is made, it will not be noted in the printed Service Guide. For ACER-AUTHORIZED SERVICE PROVIDERS, your Acer office may have a DIFFERENT part number code to those given in the FRU list of this printed Service Guide. You MUST use the list provided by your regional Acer office to order FRU parts for repair and service of customer machines.

<b>Chapter 1 System Specifications.....</b>	<b>1</b>
Features .....	1
Block Diagram .....	3
Outlook View .....	4
Indicators .....	10
Launch Keys .....	11
Using the Keyboard .....	12
Ejecting the optical (CD or DVD) drive tray .....	16
Using a computer security lock .....	17
Audio .....	18
Touchpad .....	19
Hardware Specifications and Configurations .....	21
<b>Chapter 2 System Utilities.....</b>	<b>29</b>
BIOS Setup Utility .....	29
Information .....	30
Main .....	32
Advanced .....	34
Security .....	35
Boot .....	38
Exit .....	39
<b>Chapter 3 Machine Disassembly and Replacement.....</b>	<b>40</b>
General Information .....	41
Disassembly Procedure Flowchart .....	42
Removing the Battery Pack .....	44
Removing the HDD Module/the Memory and the Wireless LAN Card/the Thermal Module and the CPU/ODD Module and LCD Module .....	45
Disassembling the Main Unit .....	49
Disassembling the LCD Module .....	53
Disassembling the External Modules .....	55
<b>Chapter 4 Troubleshooting.....</b>	<b>56</b>
System Check Procedures .....	57
Power-On Self-Test (POST) Error Message .....	61
Index of Error Messages .....	62
POST Code .....	65
Index of Symptom-to-FRU Error Message .....	66
Intermittent Problems .....	69
Undetermined Problems .....	70
Use NAPP CD to Build Master Hard Disc Drive .....	71
<b>Chapter 5 Jumper and Connector Locations.....</b>	<b>78</b>
Top View .....	78
Rear View .....	79
RTC Jumper .....	81
<b>Chapter 6 FRU(Field Replaceable Unit) List.....</b>	<b>82</b>
Exploded Diagram .....	83
Parts .....	85

# System Specifications

---

## Features

This computer was designed with the user in mind. Here are just a few of its many features:

### Performance

- Intel® Celeron® M Processor at 1.3 ~ 1.5 GHz or higher
- Intel® Pentium® M Processor at 1.5 ~ 2.13 GHz or higher
- CPU Package is uFPGA 478 Package
- Integrated Intel® PRO/Wireless 2200BG network connection (dual-mode 802.11b/g) Wi-Fi CERTIFIED™ solution

### Memory

- 256MB or 512MB of DDRII 400/533
- Upgradeable to 2GB Memory by Dual channels of SODIMM

### Display

- 15.4" WXGA+TFT LCD, supporting 1280x800 pixel resolution

### Graphics

- ATI MOBILITY™ RADEON® X700 with 128/256MB of video memory
- Microsoft® DirectX® 9.0 support
- ATI POWERPLAY™ 5.0 support
- DualView™ support
- External resolution/refresh rate
  - 2048x1536: 60/75 Hz
  - 1600x1200: 120/100/85/75/60 Hz
  - 1400x1050: 60 Hz
  - 1280x1024: 60/75/85/100/120/160 Hz
  - 1024x768: 200/160/120/100/85/75//60 Hz
  - 800x600: 200/160/120/100/85/75/60 Hz
- MPEG-1/24 and DVD/HDTV hardware-assisted capability
- S-video/TV-out (NTSC/PAL) support
- Aspire CinemaVision™ video technology

### TV Tuner

- MiniPCI type
- Reserve necessary thermal solution
- 3 TV tuner modules at lease
  - Analog w/ HW MPEG2
  - Analog+Digital w/ HS MPEG2(Hybrid)

- 
- Analog+Digital w/o HW MPEG2(Hybrid)
  - Location of the TV tuner card has to be very close to the connector

### **Audio**

- 16-bit AC'97 stereo audio
- Dual speakers and one internal microphone
- Separate audio ports for headphone--out, line-in, microphone-in and SPDIF devices
- Built-in two 1.5W speakers
- MS-Sound Compatible
- Line-out

### **Storage**

- 9.5mm height, 2.5" HDD
- 40/60/80/100/120GB
- PCI Bus Master Enhanced IDE
- Support Ultra DMA100, S.M.A.R.T

### **Communication**

- 56Kbps V.90/V.92 AC-Link modem card (MDC)
- 10/100Mbps or Giga LAN on board
- WLAN 802.11b/g or 802.11 a/b/g dual-band tri-mode Wireless with Mini-PCI interface
- Built-in 2 Antenna (which has to be placed on the top of LCD on the sides of LCD latch)

### **I/O Ports**

- Three external USB 2.0 ports
- IEEE 1394 port (4-pin)
- Ethernet (RJ-45) port
- Modem (RJ-11) port
- External display (VGA) port
- S-video port(7-pin)
- Microphones-in/Line-in jack
- Headphones/Speaker/Line-out jack with SPDIF support
- Infrared (FIR) port
- 3-in-1 card reader
- DC-in jack for AC adaptor
- TV RF input
- Composite input

### **Battery**

- 8-cell of Li-ion battery pack, (4400mAh)
- 4-cell of Li-ion battery pack, (2200mAh)
- 65W AC adaptor
- 3-hours battery life when support ATI X600 / 4-hours battery life when support Intel GFX



# Block Diagram

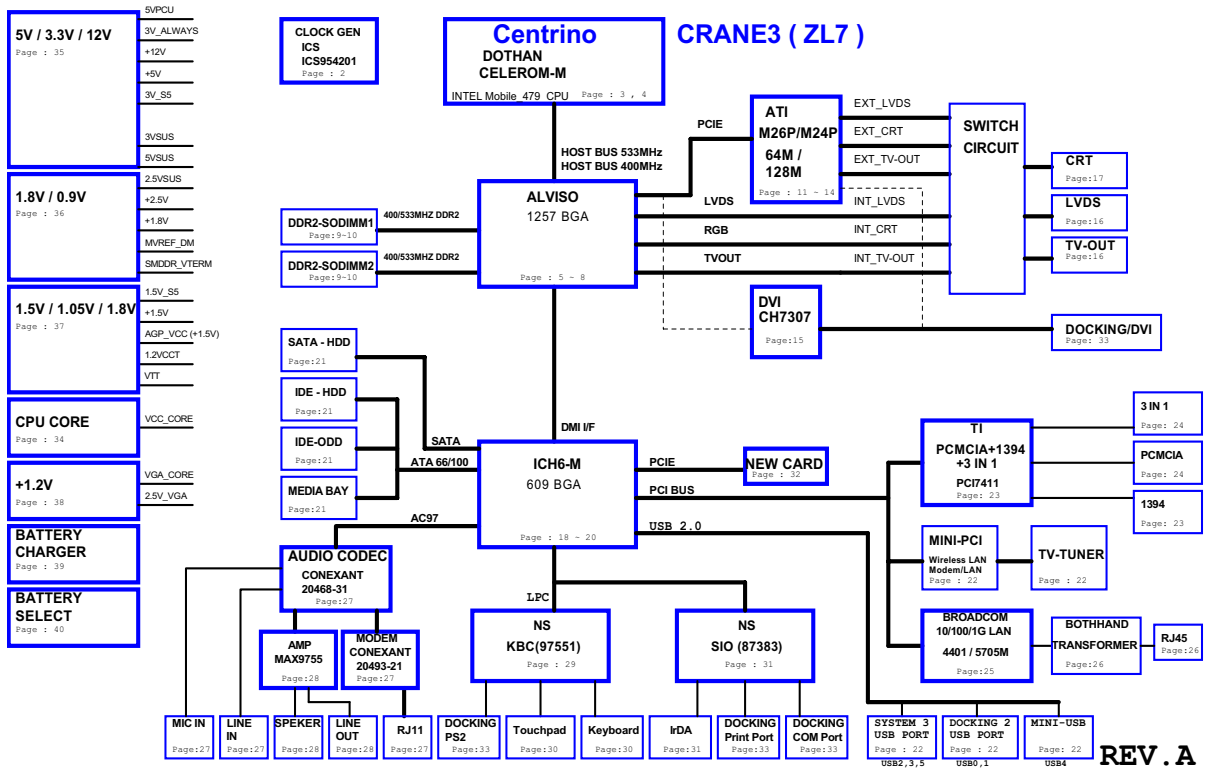

# Outlook View

A general introduction of ports allow you to connect peripheral devices, as you would with a desktop PC.

## Open View



#	Item	Description
1	Display screen	Also called Liquid-Crystal Display (LCD), displaying computer output.
2	Microphone	Internal microphone for sound recording.
3	Keyboard	Inputs data into your computer.
4	Palmrest	Comfortable support area for your hands when you use the computer.
5	Click buttons (Left, center and right)	The left and right buttons function like the left and right mouse buttons; the center button serves as a 4-way scroll button.
6	Touchpad	Touch-sensitive pointing device which functions like a computer mouse.
7	Status indicators	Light-Emitting Diodes (LEDs) that turn on and off to show the status of the computer's functions and components.
8	Launch keys	Buttons for launching frequently used programs.
9	Power button	Turns the computer on and off.

## Front View

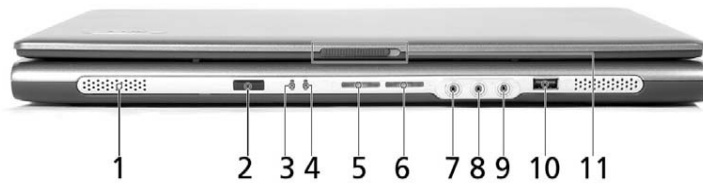

#	Icon	Item	Description
1	N/A	Speakers	Left and right speakers deliver stereo audio output.
2		CIR Receiver	Receives remote control infrared signals.
3		Power indicator	Lights when the computer is on.
4		Battery indicator	Lights when the battery is being charged.
5		Bluetooth communication button/indicator	Press to enable/disable Bluetooth function. Lights to indicate the status of Bluetooth communications.
6		Wireless communications button/indicator	Press to enable/disable Wireless function. Lights to indicate the status of wireless LAN communications. (manufacturing option)
7		Line-in jack	Accepts audio line-in devices (e.g., audio CD player, stereo walkman).
8		Mic-in jack	Accepts inputs from external microphones.
9		Speaker-Out / Line-Out / Headphone jack	Connects to audio line-out devices (e.g., speakers, headphones).
10		USB 2.0 port	Connects to Universal Serial Bus (USB) 2.0 devices (e.g., USB mouse, USB camera).
11	N/A	Latch	Locks and releases the lid.

---

## Left View

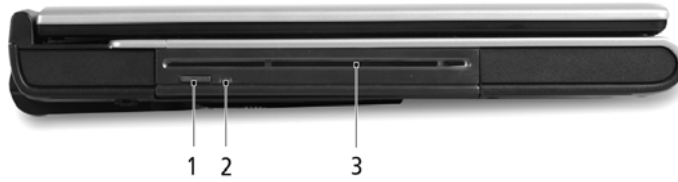

#	Item	Description
1	Slot-load optical drive eject button	Ejects the optical disk from the drive.
2	Optical disk access indicatir	Lights up when the optical drive is active.
3	Slot-load optical drive	Internal optical drive; accepts CDs and DVDs

**NOTE:** The slot-load optical drive can only accept 12 cm disks.

## Right View

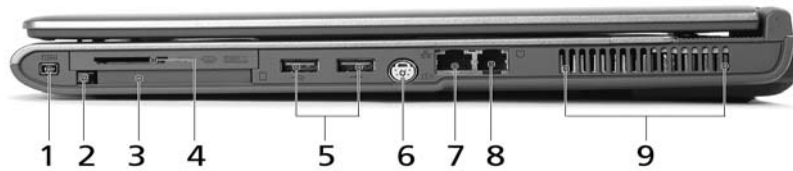

#	Item	Description
1	IEEE 1394 port	Connects to IEEE 1394 devices.
2	PC Card slot eject button	Ejects the PC Card from the slot.
3	PC Card slot	Connects to one Type II CardBus PC Card.
4	4-in-1 card reader	Accepts MS, MMC, MS PRO and SD card. Note: The 4-in-1 card reader is a manufacturing option, subject to configuration. Only one card can operate at any given time.
5	Two USB 2.0 ports	Connect to Universal Serial Bus (USB) 2.0 devices (e.g., USB mouse, USB camera).
6	S-video port	Connects to a television or display device with S-video input.
7	Network jack	Connects to an Ethernet 10/100/1000-based network (for selected models).
8	Modem jack	Connects to a phone line.
9	Ventilation slots	Enable the computer to stay cool, even after prolonged use.

**Rear View**



#	Item	Description
1	DC-in jack	Connects to an AC adapter.
2	External display port	Connects to a display device (e.g., external monitor, LCD projector).
3	RF jack	Connects to a TV antenna or cable.
4	AV input port	Accepts input signals from audiovisual(AV) devices.
5	Kensington lock slot	Connects to a Kensington-compatible computer security lock.

## Bottom View









#	Item	Description
1	Hard disk bay	Houses the computer's hard disk (secured with screws).
2	Battery release latch	Unlatches the battery to remove the battery pack.
3	Battery bay	Houses the computer's battery pack.
4	Battery lock	Locks the battery in place.
5	Cooling fan	Helps keep the computer cool. <b>NOTE:</b> Do not cover or obstruct the opening of the fan.
6	Memory compartment	Houses the computer's main memory

## Indicators

Your computer provides an array of three indicators located above the keyboard, in addition to four indicators positioned at the front of the palm rest area. These indicators show the status of the computer and its components.



The three indicators located above the keyboard provide the following status information:

Icon	Item	Description
	Caps Lock activity	Lights when Caps Lock is activated.
	Num Lock activity	Lights when Num Lock is activated.
	Media activity	Lights when the hard disk or optical drive is active.
	Bluetooth	Indicates the status of Bluetooth communication.
	Wireless LAN	Indicates the status of wireless LAN communication.
	Power	Lights up when the computer is on.
	Battery	Lights up when the battery is being charged.

**NOTE:** The keypad lock must be turned on to use the embedded numeric keypad.



---

## Launch Keys

Located at the upper-right, above the keyboard are four easy-launch buttons. They are User-Programmable Button, Mail, Web Browser, Acer Empowering Key from left to right.



Item	Default Application
P	User programmable key
e	Acer Empowering Technology(User-programmable)
Web Browser	Internet browser(User -programmable)
Mail	Email application(User-programmable)

---

# Using the Keyboard

The full-sized keyboard includes an embedded numeric keypad, separate cursor keys, two Windows keys and twelve function keys.

## Lock keys

The keyboard has four lock keys which you can toggle on and off.



The computer features three lock keys, each with its own status indicator light.

Lock Key	Description
Caps Lock	When Caps Lock is on, all alphabetic characters are typed in uppercase. Toggle on and off by pressing the Caps Lock key on the left side of the keyboard.
Num lock <Fn+F11>	When Num Lock is on, the embedded numeric keyboard can be used. Toggle on and off by pressing the Fn+  keys simultaneously.
Scroll lock <Fn+F12>	When Scroll Lock is on, the screen toggles up or down one line at a time when the up and down cursor control keys are pressed.

**NOTE:** Scroll Lock doesn't work in all applications. Toggle on and off by pressing the Fn+F12 keys simultaneously.





---

## Hot Keys

The computer employs hot keys or key combinations to access most of the computer's controls like screen brightness, volume output and the BIOS Utility.

To activate hot keys, press and hold the <Fn> key before pressing the other key in the hot key combination.



Hot Key	Function	Description
Fn-F1	Hot key help	Displays help on hot keys.
Fn-F2	Acer eSetting	Launches the Acer eSetting in the Acer eManager set by the Acer Empowering Key.
Fn-F3	Acer ePowerManagement	Launches the Acer ePowerManagement in the Acer eManager set by the Acer Empowering Key.
Fn-F4	Sleep	Puts the computer in Sleep mode.
Fn-F5	Display toggle	Switches display output between the display screen, external monitor (if connected) and both the display screen and external monitor.
Fn-F6	Screen blank	Turns the display screen backlight off to save power. Press any key to return.
Fn-F7	Touchpad toggle	Turns the internal touchpad on and off.
Fn-F8	Speaker toggle	Turns the speakers on and off.
Fn+ 	Volume up	Increases the sound volume.
Fn+ 	Volume down	Decreases the sound volume.
Fn+ 	Brightness up	Increases the screen brightness.
Fn+ 	Brightness down	Decreases the screen brightness.

## Special Keys

You can locate the Euro symbol and US dollar sign at the upper-center and/or bottom-right of your keyboard. To type:



1. Open a text editor or word processor.
2. Either directly press the **Euro** symbol at the bottom-right of the keyboard, or hold **Alt Gr** and then press the **Euro** symbol at the upper-center of the keyboard.











#### **The US dollar sign**

1. Open a text editor or word processor.
2. Either directly press the **dollar** sign at the bottom-right of the keyboard, or hold **Shift** and then press the **dollar** sign at the upper-center of the keyboard.

## ***Windows Keys***

The keyboard features two keys that perform Windows-specific functions.



Key	Description
<p>Windows logo key</p> 	<p>Pressed alone, this key has the same effect as clicking on the Windows Start button; it launches the Start menu. It can also be used with other keys to provide a variety of functions:</p> <ul style="list-style-type: none"> <li> + Tab (Activates the next Taskbar button)</li> <li> + E (Opens the My Computer window)</li> <li> + F1 (opens Help and Support)</li> <li> + F (opens the Find: All Files dialog box)</li> <li> + M (minimizes all windows)</li> <li> +  + M (undoes the minimize all windows action)</li> <li> + R (opens the Run dialog box)</li> </ul>
<p>Application key</p> 	<p>This key has the same effect as clicking the right mouse button; it opens the application's context menu.</p>

---

## ***Ejecting the optical (CD or DVD) drive tray***

To eject the optical drive tray when the computer is turned on, press the drive eject button.



When the power is off, you can eject the drive tray using the emergency eject hole.

---

## ***Using a computer security lock***

A security keylock notch, located on the rear of the computer, lets you connect a Kensington-compatible computer security lock.



Wrap a computer security lock cable around an immovable object such as a table or handle of a locked drawer. Insert the lock into the notch and turn the key to secure the lock. Some keyless models are also available.

---

## ***Audio***

The computer comes with 16-bit high-fidelity AC'97 stereo audio, and dual stereo speakers.



## ***Adjusting the Volume***

Adjusting the volume on the computer is as easy as pressing some buttons.



---

## ***Touchpad***

The build-in touchpad is a PS/2 compatible pointing device that senses movement on its surface.

The cursor responds to your finger movements on the touchpad. In addition, the two click buttons provide the same functionality as a computer mouse, while the scroll key enables easy up and down scrolling in documents and web pages.

The touchpad is located in the middle of the palm rest area, providing maximum comfort and efficiency.



### ***Touchpad Basics***

Use the touchpad as follows:



- Move your finger across the touchpad to move the cursor.
- Press the left **(1)** and right **(3)** buttons located on the edge of the touchpad to do selection and execution functions. These two buttons are similar to the left and right buttons on a mouse. Tapping on the touchpad is the same as clicking the left button
- Use the 4-way scroll **(2)** button to scroll up or down and move left or right a page. This button mimics your cursor pressing on the right scroll bar of windows applications.

Function	Left Button	Righ Button	Tap
Execute	Click twice quickly		Tap twice (at the same speed as double-clicking the mouse button)
Select	Click once		Tap once
Drag	Click and hold. Then slide your finger across the touchpad to drag the cursor over the selection.		Tap twice quickly. On the second tap, slide your finger across the touchpad to drag the cursor over the selection.
Access context menu		Click once	

**NOTE:** Keep your fingers, as well as the surface of the touchpad dry and clean. The touchpad is sensitive to your finger movements: the lighter the touch, the better the response. Tapping hard will not increase the touchpad's responsiveness.

# Hardware Specifications and Configurations

## Processor

Item	Specification
CPU type	Intel® Pentium® M Processor at 1.5 ~2.13 GHz or higher Intel® Celeron® M Processor at 1.3~1.5 GHz or higher
CPU package	uFPGA 478
CPU core voltage	Depend on DVI
CPU I/O voltage	1.2V

## System Board Major Chips

Item	Controller
System core logic	Intel® 915PM / ICH6-M Intel® 915GM / ICH6-M
Super I/O controller	KBC (97551), LPC interface
Audio controller	Conexant Codec
Video controller	ATI M26P(Manufacturing option) UMA
Hard disk drive controller	ICH6-M
Keyboard controller	KBC 97551
IrDA controller	SIO 87383
DVI controller	CH7307
PCMCIA/ card reader / 1394 controller	TI PCI7411
DDR-soDIMM controller	915PM/915GM

## BIOS

Item	Specification
BIOS vendor	Phoenix
BIOS Version	Phoenix First BIOS
BIOS ROM type	Flash ROM
BIOS ROM size	512KB
BIOS package	32 lead of TSSOP
BIOS password control	Set by setup manual

Item	Specification
Cache controller	Built-in CPU
Cache size	2 MB
1st level cache control	Always enabled
2nd level cache control	Always enabled
Cache scheme control	Always enabled

### ***System Memory***

<b>Item</b>	<b>Specification</b>
Memory controller	915PM/915GM
Memory size	256MB/512MB
DIMM socket number	2
Supports memory size per slot	1024 MB
Supports maximum memory size	2GB (with dual soDIMM modules)
Supports DIMM type	DDRII SDRAM Standard
Supports DIMM Speed	400/533 MHz
Supports DIMM voltage	1.8V
Memory module combinations	You can install memory modules in any combinations as long as they match the above specifications.

### ***LAN Interface***

<b>Item</b>	<b>Specification</b>
Supports LAN protocol	10/100/1000 Mbps Fast Ethernet connection
LAN connector type	RJ45
Wireless LAN	InviLink. 802.11b/g dual-band tri-mode Wireless or 802.11 a/b/g dual-band tri-mode Wireless
LAN connector location	Right side

### ***Modem/Bluetooth Interface***

<b>Item</b>	<b>Specification</b>
Data modem data baud rate (bps)	56K ITU
Supports modem/bluetooth protocol	V.90/V.92 AC-Link modem with PTT approval Wake-on-Ring ready
Modem connector type	RJ11
Modem connector location	Right side

### **VGA**

<b>Notice</b>	<b>Discrete</b>	<b>UMA</b>
Chipset for suitable VGA type	915PM	915GM

### ***USB Port***

<b>Item</b>	<b>Specification</b>
USB compliancy level	2.0
OHCI	USB 2.0
Number of USB port	3
Location	Right Side *2 Front Side *1

### Audio Port

Item	Specification
Audio Controller	AC' 97 Codec
Audio onboard or optional	Built-in
Mono or Stereo	Stereo
Resolution	20 bit stereo Digital to analog converter 18 bit stereo Analog to Digital converter
Compatibility	Microsoft PC99/2100, AC97 2.3 & WHQL/WLP2.0
Mixed sound source	CD
Sampling rate	48 KHz
Internal microphone	Yes
Internal speaker / Quantity	Yes / 2

### PCMCIA Port

Item	Specification
PCMCIA controller	PCI7411
Supports card type	Type II
Number of slots	One type-II
Access location	Right Side
Supports ZV (Zoomed Video) port	No
Supports 32 bit CardBus	Yes

### Keyboard

Item	Specification
Keyboard controller	KBC 97551
Keyboard vendor & model name	Standard keyboard w launch button embedded
Total number of keypads	<input type="checkbox"/> 88-89 keys Acer Fine Touch™ keyboard
Touchpad with 4-way integrated scroll button	Yes
12 function keys	<input type="checkbox"/> four cursor keys <input type="checkbox"/> two Windows keys <input type="checkbox"/> Hotkey controls <input type="checkbox"/> embedded numeric keypad <input type="checkbox"/> international language support (for TM4600/TM4100)
Four easy-launch buttons	<input type="checkbox"/> Internet browser <input type="checkbox"/> email with LED <input type="checkbox"/> Empowering key <input type="checkbox"/> one user-programmable button
Two front access LED buttons	<input type="checkbox"/> WLAN LED button <input type="checkbox"/> Bluetooth LED button

## Battery

Item	Specification
Vendor & model name	Sony/Sanyo
Battery Type	Li-ion
Pack capacity	65Wh
Cell voltage	3.7V/cell/2000mAh High discharge rate
Number of battery cell	8-cell(65W) 4-cell(32W)
<b>Package configuration</b>	
Pin 1 Pin 2	BATT+: Battery+, Battery Positive Terminal
Pin 3	ID : Identify Pin (Note 1)
Pin 4	B/I : Battery-In Pin
Pin 5	TS : Connect to Thermister
Pin 6	SMD : SMBus data interface I/O pin
Pin 7	SMC : SMBus clock interface I/O pin
Pin 8 Pin 9	GND : Battery Negative Terminal

## LCD :15.4" WXGA LCD

Item	Specification				
Vendor & model name	CMO N154I1-L09	LPL LP154W01- A5	Hitachi TX39D85V C1FAA	Samsung LTN154X3- L01	QDI QDI15TL02- 01
<b>Mechanical Specifications</b>					
LCD display area (diagonal, inch)	15.4"	15.4"	15.4"	15.4"	15.4"
Display technology	TFT	TFT	TFT	TFT	TFT
Resolution	WXGA (1280*800)	WXGA (1280*800)	WXGA (1280*800)	WSXGA (1280*800)	WSXGA (1280*800)
Supports colors	16.7 million	16.7 million	16.7 million	16.7 million	16.7 million
<b>Optical Specification</b>					
Brightness control	keyboard hotkey	keyboard hotkey	keyboard hotkey	keyboard hotkey	keyboard hotkey
Contrast control	No	No	No	No	No
Suspend/Standby control	Yes	Yes	Yes	Yes	Yes
Electrical Specification					

**LCD :15.4" WXGA LCD**

Item	Specification				
Supply voltage for LCD display (V)	3.3	3.3	3.3	3.3	3.3
Supply voltage for LCD backlight (Vrms)	785	785	730	735	735

**AC Adapter**

Item	Specification
Vendor & model name	Delta 3-pin, 19V 3.95A, 64W Hipro 3-pin, 19V 3.95A, 65W Lite-on 3-pin, 19V 3.95A, 60W
Details	65W Li-ion battery pack (8-cell) <ul style="list-style-type: none"> <li><input type="checkbox"/> 4-hour battery life (support intel GFX)</li> <li><input type="checkbox"/> 3-hour battery life (support ATI X600)</li> <li><input type="checkbox"/> 1.5-hour quick-charge, 3.5-hour charge-in use</li> </ul>
<b>Input Requirements</b>	
Maximum input current (A, @100Vac, full load)	1.8A max@3.5A/100Vac and 240 Vac
Nominal frequency (Hz)	47 - 63
Frequency variation range (Hz)	47 - 63
Nominal voltages (Vrms)	90 - 264
Inrush current	The maximum inrush current will be less than 50A and 100A when the adapter is connected to 100Vac(60Hz) and 240Vac(50Hz) respectively.
Efficiency	High efficiency 85% minimum, at 100~240Vac AC input, full load, warm-up condition.
<b>Output Ratings (CV mode)</b>	
DC output voltage	Offers constant voltage 19.0V output source with 150W max output power capacity.
Noise + Ripple	300mvp-pmax (20MHz bandwidth) for resistor load
Output current	0 A (min.) 3.5A (max.)
<b>Output Ratings (CC mode)</b>	
DC output voltage	18.0 ~ 20.0
Constant output	7.9A
<b>Dynamic Output Characteristics</b>	
Start-up time	3 sec. (@115 Vac and 230Vac full load)
Hold up time	5ms min. (@115 Vac input, full load)
Over Voltage Protection (OVP)	25V
Short circuit protection	Output can be shorted without damage, and auto recovery
Electrostatic discharge (ESD)	15kV (at air discharge) 8kV (at contact discharge)
<b>Dielectric Withstand Voltage</b>	
Primary to secondary	4242 Vdc for 1 second-
Leakage current	60uA at 240Vac/60Hz

## AC Adapter

Item	Specification
Regulatory Requirements	1. FCC class B requirements (USA) 2. VDE class B requirements (German) 3. VCCI classII requirements (Japan)

## Power Management

ACPI Mode	Power Management
Mech. Off (G3)	All devices in the system are turned off completely.
Soft Off (G2/S5)	OS initiated shutdown. All devices in the system are turned off completely.
Working (G0/S0)	Individual devices such as the CPU and hard disk may be power managed in this state.
Sleeping State (S3)	CPU Power Down VGA Power Down PCMCIA Suspend Audio Power Down Hard Disk Power Down Super I/O Power Down
Sleeping State (S4)	Also called Hibernate state. System saves all system states and data onto the disk prior to power off the whole system.

## Dimensions and Weight

Item	Details	
	Aspire 1690	Aspire 3510
Deminsions	364(W) x 279(D) x 33.9/38.9 (H)mm	
Weight	6.6lbs (3kg)	

## Environmental Requirements

Item	Specification
Temperature	
Operating	+5 ~ +35°C
Non-operating	-20 ~ +65°C (storage package)
Humidity	
Operating	20% ~ 80% without condensation
Altitude	Operating sea level 0 to 10,000ft
	Storage sea level 0 to 40,000ft



TOSHIBA			
Model Name	MK4025GAS ,KA100A, 40GB	Pluto MK6025GAS 60GB	Pluto MK8025GAS, 8MB, 80GB
<b>Data Storage Physical</b>			
Per drive, formatted	40.007GB	60.0116GB	80.012GB
Data Heads	2	4	4
Number of Disks	1	2	2
<b>Logical Configuration</b>			
Heads	16	16	16
Cylinders	16,383	16,383	16,383
User Sectors/Track at zone 0	63	63	63
Logical Blocks (LBA)	78,140,160	117,210,240	156,301,488
<b>Data Transfer Rate</b>			
Max transfer rate to host	100MB/sec	100MB/sec	100MB/sec
<b>Seek Time</b>			
Track-to-track	2ms	2ms	2ms
Average	12ms	12ms	12ms
Maximum	22ms	22ms	22ms

TOSHIBA			
<b>Nominal Power Requirements</b>			
Logic	+5V(±5 %)	+5V(±5 %)	+5V(±5 %)
Start	4.7watts	5.0watts	4.7watts
Seeking	2.6watts	2.9watts	2.6watts
Reading/Writing	2.3watts	2.5watts	2.3watts
Idle	0.9watts	1.05watts	0.9watts
Standby	0.25watts	0.25watts	0.25watts
Sleep	0.1watts	0.1watts	0.1watts
<b>Other</b>			
Rotational Speed	4,200rpm	5,400rpm	4,200rpm
Average Latency	7.14ms	5.56ms	7.14ms
Interface	ATA-2/3/4/5/6	ATA-5	ATA-2/3/4/5/6
Buffer	8MB	16MB	8MB
<b>Physical &amp; Environmental Specs</b>			
<b>Dimensions/Weight:</b>			
Height	0.37" (9.5mm)	0.37" (9.5mm)	0.37"(9.5mm)
Width	2.75" (69.85mm)	2.75" (69.85mm)	2.75" (69.85mm)
Depth	3.94" (100mm)	3.94" (100mm)	3.94"(100mm)
Weight	3.35 oz (94g)	3.56 oz (101g)	3.49 oz (99g)
<b>Ambient Temperature:</b>			
Operating	41° - 131° F (5 to 55° C)	41° - 131° F (5 to 55° C)	41° - 131° F (5 to 55° C)

Non-Operating	-4° - 140° F (-20 to 60° C)	-4° - 140° F (-20 to 60° C)	-4° - 140° F (-20 to 60° C)
Shipping	-40° - 158° F (-40 to 70° C)	-40° - 158° F (-40 to 70° C)	-40° - 158° F (-40 to 70° C)
<b>Vibration and Shock</b>			
Operating Vibration	9.8 M/S <sup>2</sup> (1.0G), 5 - 500 Hz	9.8 M/S <sup>2</sup> (1.0G), 5 - 500 Hz	9.8 M/S <sup>2</sup> (1.0G), 5 - 500 Hz
Operating Shock	200g	200g	200g
Non-Operating Shock	800g	800g	800g
<b>Reliability Characteristics</b>			
<b>Error Rates</b>			
Non-recoverable	1 in 10 <sup>13</sup> bits	1 in 10 <sup>13</sup> bits	1 in 10 <sup>13</sup> bits
Seek	1 in 10 <sup>6</sup> seeks	1 in 10 <sup>6</sup> seeks	1 in 10 <sup>6</sup> seeks
<b>Other</b>			
Preventive Maintenance	None	None	None
MTTF (Power on hours)	300,000	300,000	300,000
Product Life	5 years or 20,000 power ON hours	5 years or 20,000 power ON hours	5 years or 20,000 power ON hours

## System Utilities

### BIOS Setup Utility

The BIOS Setup Utility is a hardware configuration program built into your computer's BIOS (Basic Input/Output System).

Your computer is already properly configured and optimized, and you do not need to run this utility. However, if you encounter configuration problems, you may need to run Setup. Please also refer to Chapter 4 Troubleshooting when problem arises.

To activate the BIOS Utility, press **F2** during POST (when "Press <F2> to enter Setup" message is prompted on the bottom of screen).

The setup screen displays BIOS as follows: Navigating the BIOS Utility

Function	Item
Information	Display the system informations
Main	Allows the user to specify standard IBM PC AT system parameters
Advanced	Provides advanced settings of the system
Security	Provides security settings of the system
Boot	Allows the user to specify the boot options
Exit	Allows the user to save CMOS setting and exit Setup

During setup, all Fn function keys and power saving functions are disabled.

There are five menu options: Main, Advanced, Security, Boot and Exit.

Follow these instructions:

- To choose a menu, use the cursor left/right keys (**←** **→**).
- To choose a parameter, use the cursor up/down keys (**↑** **↓**).
- To change the value of a parameter, press **F5** or **F6**.
- Press **ESC** while you are in any of the menu options to go to the Exit menu.
- In any menu, you can load default settings by pressing **F9**. You can also press **F10** to save any changes made and exit the BIOS Setup Utility.

**NOTE:** You can change the value of a parameter if it is enclosed in square brackets. Navigation keys for a particular menu are shown on the bottom of the screen. Help for parameters are found in the Item Specific Help part of the screen. Read this carefully when making changes to parameter values.

# Information

**PhoenixBIOS Setup Utility**

Info.	Main	Advanced	Security	Boot	Exit
<p>CPU Type: Intel(R) Pentium(R) M processor 1.86GHz            CPU Speed: 1866 MHz</p> <p>HDD Model Name: ST9100822A            HDD Serial Number: 3LG0Y4FE            HATAPI Device: Slimtype DVDRW S0SW-833S            System BIOS Version: 3A02            VGA BIOS Version: ATi 009.010.002.023            KBC Version: 1A11            Serial Number: LXT123456705270008EF00            Asset Tag Number:            Product Name: Aspire 5510            Manufacturer Name: Acer            UUID: 003B4852C5630010A0EA00C09FAE9B34</p>					
F1 Help	↑↓ Select Item	F5/F6 Change Values	F9 Setup Defaults		
Esc Exit	←→ Select Menu	Enter Select	▶ Sub-Menu	F10 Save and Exit	

Parameter	Description
CPU Type	
CPU Speed	
HDD Model Name	This item will show the Model name of HDD installed on Primary IDE master. The hard disk model name is automatically detected by the system. If there is no hard disk present or unknown type, "None" should be shown on this field
HDD Serial Number	This item will show the Serial number of HDD installed on Primary IDE master. If no Hard disk or other devices are installed on Primary IDE master, then it will display a blank line
ATAPI Model Name	This item will show the model name of DVD/CD-ROM drive installed on system. The DVD/CD-ROM model name is automatically detected by the system. If there is no DVD/CD-ROM model present or unknown type, "None" should be shown on this field
System BIOS Version	This field reports the BIOS version of system
VGA BIOS Version	This field reports the VGA version of the system
KBC Version	
Serial Number	This item will show the Serial number of system.
Asset Tag Number	This item will show the Asset Tag number of the system.

---

<b>Parameter</b>	<b>Description</b>
Product Name	This field will show product name.
Manufacturer Name	This field will show manufacturer name.
UUID	This will be visible only when there is an internal LAN device present.

# Main

This menu provides you the information of the system.

PhoenixBIOS Setup Utility					
Info.	Main	Advanced	Security	Boot	Exit
System Time: [11:59:38] System Date: [07/27/2005]  System Memory: 640 KB Extended Memory: 254 KB Video Memory: 128 MB  Quiet Boot: [Enabled] Power on Display: [Auto ] Network boot: [Enabled] F12 Boot Menu: [Disabled] D2D Recovery: [Enabled]					Item Specific Help  <Tab>, <Shift-Tab>, or <Enter> selects field.
F1 Help	↑↓ Select Item	F5/F6 Change Values	F9 Setup Defaults		
Esc Exit	←→ Select Menu	Enter Select	▶ Sub-Menu	F10 Save and Exit	

Parameter	Description
System Time / System Date	The hours are displayed with 24 hours format. The values set in these two fields take effect immediately.
System Memory	This field reports the memory size of system base memory. The size is fixed to 640KB.
Extended Memory	This field reports the memory size of the extended memory in the system. Extended Memory size = Total memory size - 1 MB
Video Memory	VGA Memory size = 128MB
Quiet Boot	Customer Logo display will be shown during POST when it is selected.
Power on display	<b>Auto:</b> During power on process, the system will detect if any display device is connected on external video port. If any external display device is connected, the power on display will be in CRT (or projector) only mode. Otherwise it will be in LCD only mode. <b>Both:</b> Simultaneously enable both the integrated LCD screen and the system's external video port (for an external CRT or projector).
Network boot	When this is selected, Boot from LAN feature is enabled. When this is not selected, Boot from LAN feature is then disabled.

---

<b>Parameter</b>	<b>Description</b>
F12 Boot Menu	When this is selected, users can modify device boot priority by pressing F12 key during POST. When this is not selected, device boot priority will not be adjustable during POST.
D2D Recovery	Allow user to enable/disable the Disk-to-Disk recovery
Processor Power Management	Selects the Processor Power Management desired: Disabled= C states and GV1/GV3 are disabled GV1/GV3 only= C states are disabled C States Only= GV1/GV3 are disabled Enabled= C States and GV1/GV3 are enabled

## Advanced

The Advanced screen contains parameters involving your hardware devices. It also provides advanced settings of the system.

PhoenixBIOS Setup Utility					
Info.	Main	Advanced	Security	Boot	Exit
Infrared Port:		[Auto]	Item Specific Help		
			Configure serial port B using oprions:  [Disabled] No configuration  [Enabled] User configuration  [Auto] BIOS or OS chooses configuration  (OS Controlled) Displayed when controlled by OS		
F1 Help	↑ ↓ Select Item	F5/F6 Change Values	F9 Setup Defaults		
Esc Exit	← → Select Menu	Enter Select	▶ Sub-Menu	F10 Save and Exit	

The table below describes the parameters in the screen. Settings in **boldface** are the default and suggested parameter settings.

	Description	Option
Infrared Port	Configure serial port B using options: [Disabled]: No configuration [Enabled]: User configuration [Auto]: BIOS or OS chooses configuration (OS Controlled) Displayedd when controlled by OS	Disabled Enabled <b>Auto</b>



# Security

The Security screen contains parameters that help safeguard and protect your computer from unauthorized use.

PhoenixBIOS Setup Utility			
Info.	Main	Advanced	Security
Supervisor Password Is: Clear User Password Is: Clear HDD Password Is: Clear HDD Master ID: 19894480 Set Supervisor Password [Enter] Set User Password [Enter] Set HDD Password [Enter] Password on Boot: [Disabled]			Item Specific Help Supervisor Password controls accesses of the setup utility.
F1 Help	↑ ↓ Select Item	F5/F6 Change Values	F9 Setup Defaults
Esc Exit	← → Select Menu	Enter Select ▶ Sub-Menu	F10 Save and Exit

The table below describes the parameters in this screen. Settings in **boldface** are the default and suggested parameter settings.

Parameter	Description	Option
Supervisor Password Is	N/A	N/A
User Password Is	N/A	N/A
HDD Password Is	N/A	N/A
HDD Master ID	N/A	N/A
Set Supervisor Password	Press Enter to set the administrator password. When set, this password protects the BIOS Setup Utility from unauthorized access. [Set]: System password is set [Clear]: System password is not set	Length -- No more than 8 characters Characters -- 0-9, A-Z (not case sensitive)
Set User Password		

Parameter	Description	Option
Set HDD Password	When shown as [Locked], the hard drive password currently can not be changed or disabled. To change or disable it, turn off the system and enter Setup immediately after turning it back on. Press [Enter] to input change, or disable hard drive password.	<b>Enter</b>
Password on boot	Defines whether a password is required or not while the events defined in this group happened. The following sub-options are all requires the Supervisor password for changes and should be grayed out if the user password was used to enter setup. Allows the user to specify whether or not a password is required to boot.	<b>Disabled</b> Enabled

### ***Set Supervisor/User Password***

If password on boot is required, the password must be set otherwise it cannot be enabled.

The formats of the password are as follows:

Length        No more than 8 characters

Characters    0-9,A-Z (not case sensitive)

While these fields are highlighted and press "Enter", a window similar to the following is shown:

Set SupervisorPassword		
Enter New Password	[	]
Confirm New Password	[	]

If there is an old password then setup will prompt with the following window instead and a current password will be required to be entered at first:

Set Supervisor Password		
Enter current password	[	]
Enter New Password	[	]
Confirm New Password	[	]

---

User can now type password in field “Enter New Password”, and re-enter password in field “Confirm New Password” for verification.

If the verification is OK:

The password setting is complete after user presses enter.

Setup Notice  
Changes have been saved.  
[ continue]

If the current password entered does not match the actual current password:

Setup Warning  
Invalid password  
Re-enter Password  
[ continue]

If the new password and confirm new password strings do not match:

Setup Warning  
Password do not match  
Re-enter Password

## Boot

This menu allows the user to decide the order of boot devices to load the operating system. Bootable devices includes the distette drive in module bay, the onboard hard disk drive and the CD-ROM in module bay and onboard LAN device.

PhoenixBIOS Setup Utility			
Info.	Main	Advanced	Security
			Boot
			Exit
+Hard Drive CD-ROM/DVD Drive Network Boot Floppy Devices			Item Specific Help  + and - indicate device categories. Use <Enter> to expand/collapse.  Boot order is top-down using only the top device in each category.  Use <F6> and <F5> to move highlighted item up and down.
F1 Help	↑↓ Select Item	F5/F6 Change Values	F9 Setup Defaults
Esc Exit	←→ Select Menu	Enter Select ▶ Sub-Menu	F10 Save and Exit

Parameter	Description
+Hard Drive	+ and - indicate device categories. Use <Enter> to expand/collapse.
Floppy Devices	
CD-ROM/DVD Drive	Boot order is top-down using only the top device in each category.
Network Boot	Use <F6> and <F5> to move highlighted item up and down.

## Exit

The Exit screen contains parameters that help safeguard and protect your computer from unauthorized use.

PhoenixBIOS Setup Utility					
Info.	Main	Advanced	Security	Boot	Exit
Exit Saving Changes Exit Discarding Changes Load Setup Defaults Discard Changes Save Changes					Item Specific Help  Exit System Setup and save your changes to CMOS.
F1 Help	↑↓ Select Item	F5/F6 Change Values	F9 Setup Defaults		
Esc Exit	←→ Select Menu	Enter Select	▶ Sub-Menu	F10 Save and Exit	

The table below describes the parameters in this screen.

Parameter	Description
Exit Saving Changes	Exit System Setup and save your changes to CMOS
Exit Discarding Changes	Exit utility without saving Setup data to CMOS
Load Setup Default	Load default values for all SETUP items
Discard Changes	Load previous values from CMOS for all SETUP items
Save Changes	Save Setup Data to CMOS

## ***Machine Disassembly and Replacement***

---

This chapter contains step-by-step procedures on how to disassemble the notebook computer for maintenance and troubleshooting.

To disassemble the computer, you need the following tools:

- Wrist grounding strap and conductive mat for preventing electrostatic discharge
- Small Philips screw driver
- Philips screwdriver
- Plastic flat head screw driver
- Tweezers

**NOTE:** The screws for the different components vary in size. During the disassembly process, group the screws with the corresponding components to avoid mismatch when putting back the components. When you remove the stripe cover, please be careful not to scrape the cover.

# General Information

## Before You Begin

Before proceeding with the disassembly procedure, make sure that you do the following:

1. Turn off the power to the system and all peripherals.
2. Unplug the AC adapter and all power and signal cables from the system.
3. Remove the battery pack.

**NOTE:** The screws used to secure bottom case and upper case are more than one type. Please group same type of screw together as you disassemble the system for service purpose. The image below is for your reference. Please pay attention to the explanation below.

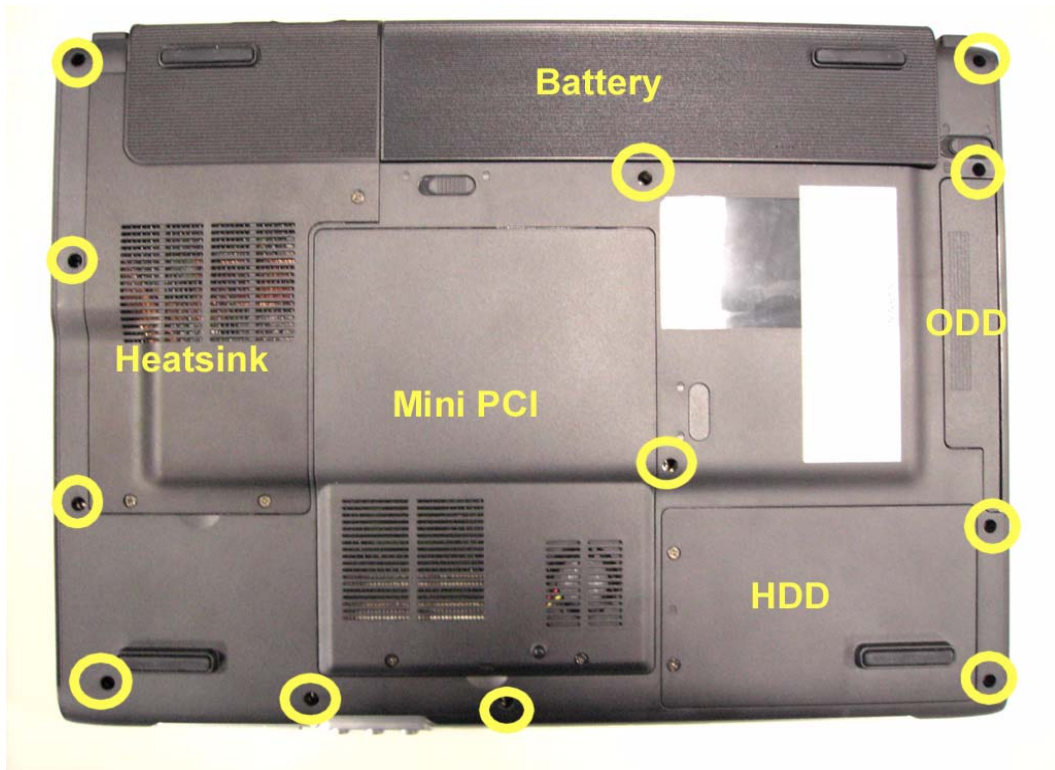

The screws that secure heatsink cover, Mini PCI cover and HDD cover are with the covers. There is no need to worry about mix them up.

Screw Type	Location	Quantity
M2.5*6	Bottom case and IO bezel (highlight with yellow circle)	12
M2.5*6	Remove the HDD cover then you will see.	1
M2.5*6	Remove the Mini PCI cover then you will see.	3
M2.5*3	Remove the battery then you will see.	1

# Disassembly Procedure Flowchart

The flowchart on the succeeding page gives you a graphic representation on the entire disassembly sequence and instructs you on the components that need to be removed during servicing. For example, if you want to remove the system board, you must first remove the keyboard, then disassemble the inside assembly frame in that order.

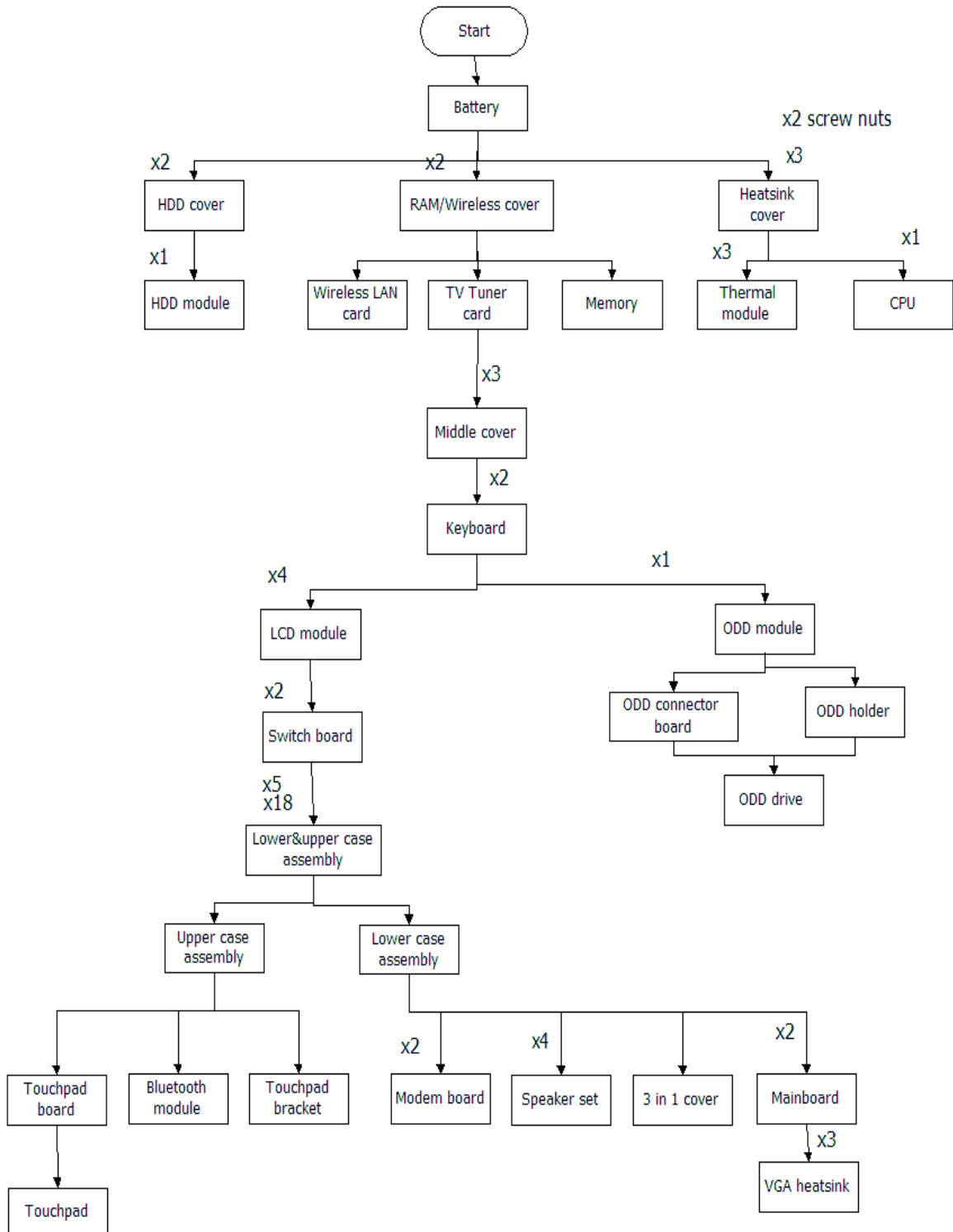



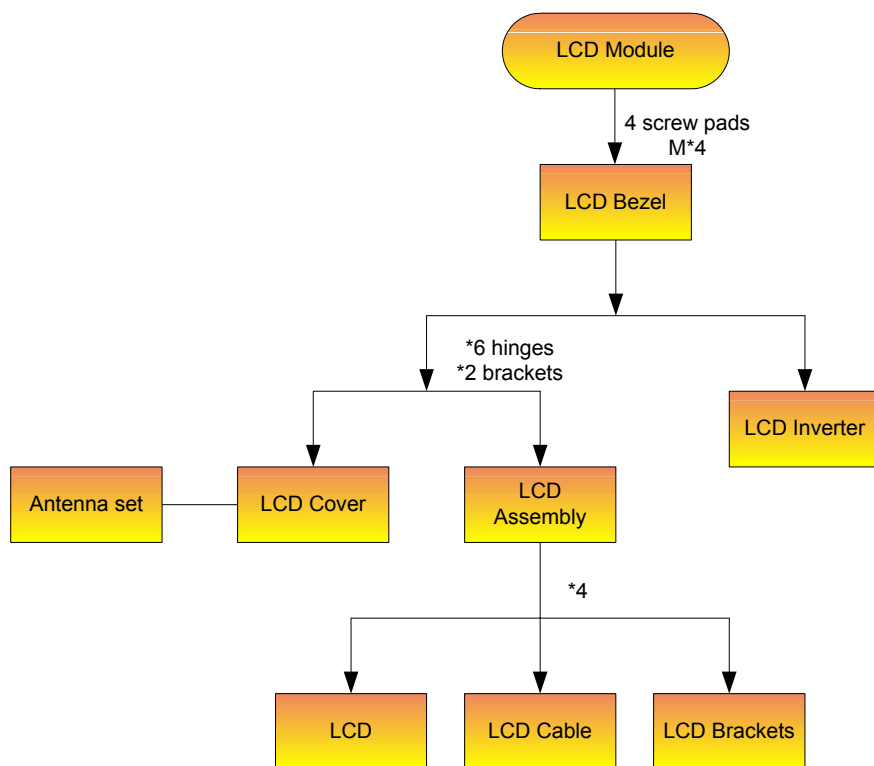

**Screw List**

Item	Description	
	SCREW M2.0X3.0-I-NI-NYLOK	86.A03V7.012
	SCREW I2.5*3M-BNIH(M2.5L3)	86.T25V7.012
	SCREW M2.5*4L-BZN-NYLOK	86.A03V7.006
	SCREW M2.0X5-I-NI-NYLOK	86.T23V7.006
	SCREW MM25060IL69	86.A08V7.004
	SCREW M2.0*5-I(NI)(NYLOK)	86.T23V7.010
	SCREW M2.0X2.5-I-NI-NYLOK	86.A03V7.007
	SCREW I2*3M-NIHY (M2L3)	86.T25V7.008
	SCREW M1.7*3.0-I (BK)	86.T50V7.001
	SCREW I3*3.5M-NIH(M3L3.5)	86.A03V7.011

---

## ***Removing the Battery Pack***

1. Unlock the battery lock.
2. Slide the battery latch as shown then remove the battery pack.



---

## ***Removing the HDD Module/the Memory and the Wireless LAN Card/the Thermal Module and the CPU/ODD Module and LCD Module***

### ***Removing the HDD Module***

1. Remove the two screws holding the HDD cover.
2. Remove the HDD cover.
3. Detach the HDD module then remove it.



### ***Removing the Memory and the Wireless LAN Card***

1. Remove the two screws that secure the RAM/Wireless cover.
2. Remove the RAM/Wireless cover.



3. Disconnect the TV tuner cable and the antenna from the TV tuner board.
4. Pop up the TV tuner board and remove it.

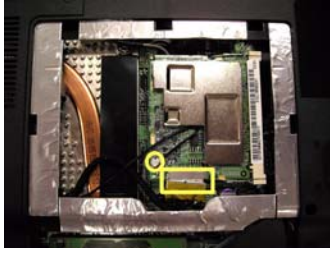

5. Pop up the memory then remove it.
6. Disconnect the auxiliary and the main wireless antennae.
7. Pop the wireless LAN card then remove it.

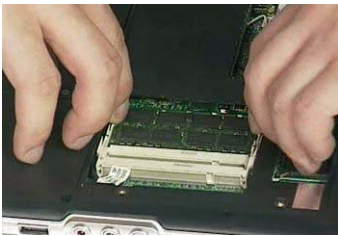

## ***Removing the Thermal Module and CPU***

1. Remove the three screws that secure the heatsink cover.
2. Remove another two screws on rear side with hex screwdriver.
3. Remove the heatsink cover.



4. Remove the three screws that secure the thermal module.
5. Disconnect the fan cable.



6. Use a flat-bladed screwdriver to release the CPU lock.
7. Remove the CPU from the socket carefully.

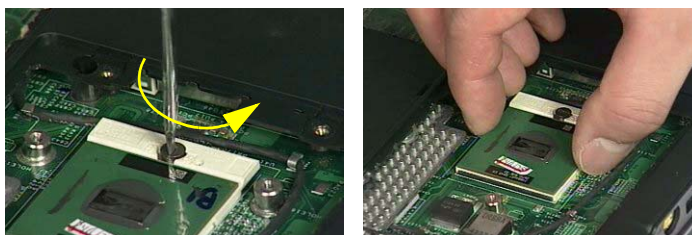

## Removing the LCD Module

1. Remove the three screws holding the middle cover.
2. Open the LCD module as the picture shown then detach the middle cover from the main unit.



3. Remove the two screws that secure the keyboard as shown.
4. Turn over the keyboard as shown and disconnect the keyboard cable then remove the keyboard.
5. Pull out the antenna set with a tweezers then take out the antenna set from the main unit.



6. Remove the screw that fastens the ODD module.
7. Turn over the notebook computer then detach the ODD module carefully.

**NOTE:** When you reattach the ODD, please make sure you attach the ODD module completely to the main unit. Otherwise, you can not fasten the screw and the screw may damage the main board.

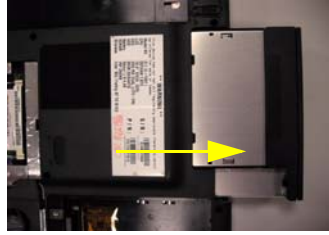

8. Disconnect the LCD coaxial cable.
9. Remove the four screws holding the right and the left hinge. Two on each side.
10. Then detach the LCD module from the main unit.

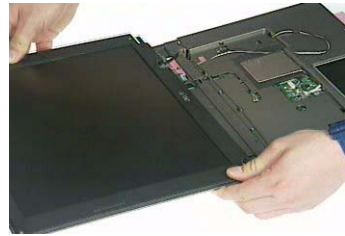
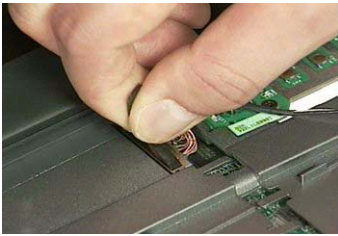

---

## ***Disassembling the Main Unit***

### ***Separate the Main Unit Into the Upper and the Lower Case Assembly***

1. Remove the two screws holding the switch board.
2. Remove the switch board.
3. Disconnect the touchpad FFC from the main board.



4. Disconnect the bluetooth cable.
5. Remove the five screws that secure the upper case.
6. Remove the eighteen screws on the bottom as shown.

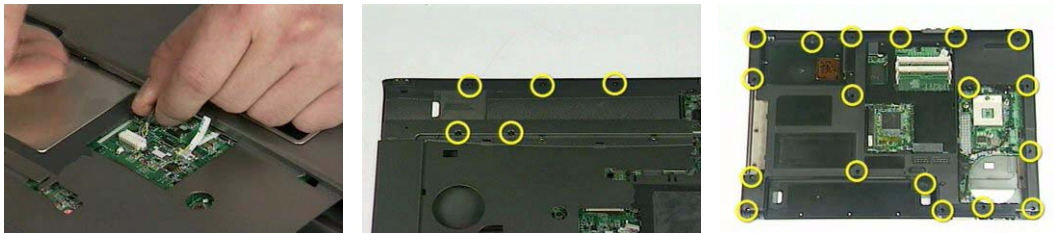

7. Detach the upper case assembly and place it next to the lower case assembly.
8. Disconnect the microphone cable then remove the upper case assembly.

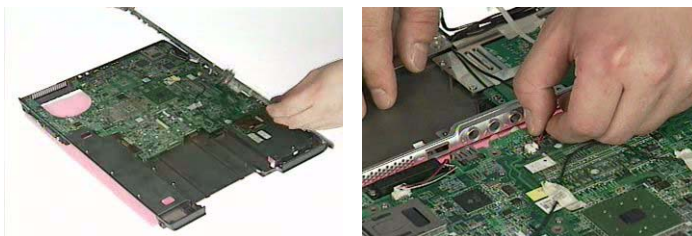

## Disassembling the Upper Case Assembly

1. Disconnect the touchpad board to touchpad FFC.
2. Disconnect the touchpad board to main board FFC.
3. Then detach the touchpad board to main board FFC from the touchpad board.

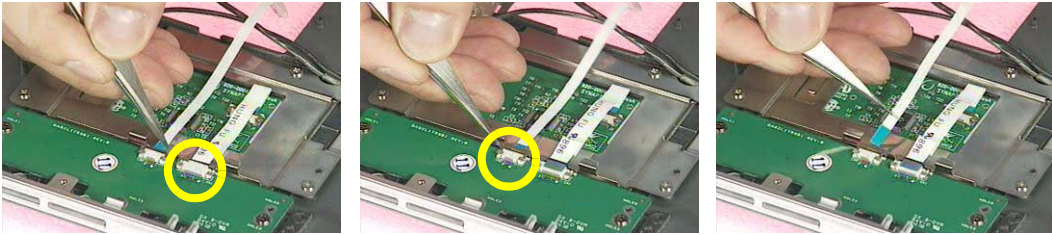

4. Remove the three screws that secure the touchpad board.
5. Remove the touchpad board from the upper case.
6. Disconnect the touchpad board to touchpad FFC.



7. Remove the touchpad board to touchpad FFC from the upper case assembly.
8. Remove the four screws holding the touchpad bracket.
9. Detach the touchpad bracket from the upper case assembly.

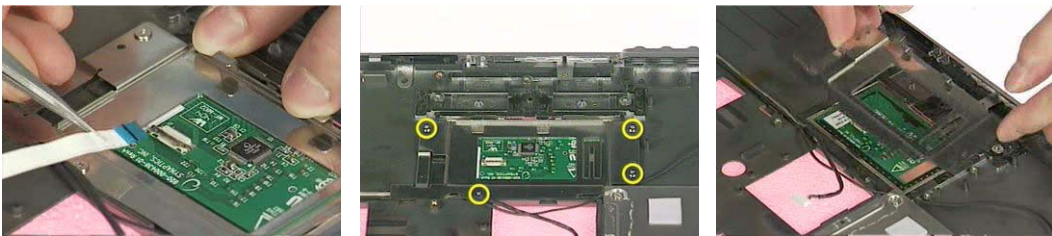

10. Remove the touchpad from the upper case.
11. Remove the two screws that secure the bluetooth module.
12. Disconnect the bluetooth module then remove it.





## Disassembling the Lower Case Assembly

1. Disconnect the MDC cable from the modem board.
2. Detach the MDC cable from the main board.
3. Remove the two screws holding the modem board.



4. Remove the modem board from the lower case.
5. Disconnect the speaker cable from the main board.
6. Remove the two screws that secure the main board.

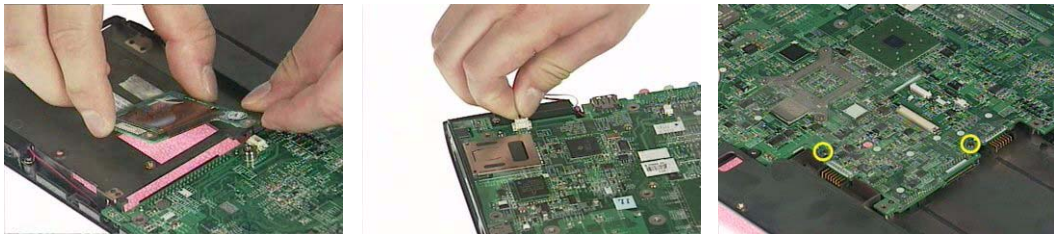

7. Remove the two screw nuts as shown.
8. The you can detach the main board from the upper case.
9. Remove the three screws that secure the VGA heatsink.



10. Remove the VGA heatsink from the main board as shown.
11. Remove the three in one cover from the lower case.
12. Remove the two screws that secure the speaker set on one side.



- 
13. Then remove another two screws holding the speaker set on the other side.
  14. Then take out the speaker set from the lower case.



## ***Disassembling the LCD Module***

1. Remove the four screw caps as shown.
2. Remove the four screws holding the LCD bezel.
3. Then detach the LCD bezel from the LCD module.



4. Disconnect the inverter board then remove it.
5. Remove the three screws holding the right hinge.
6. Then remove the three screws that secure the left hinge.

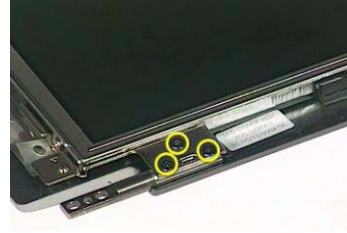
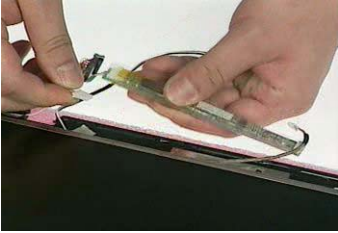

7. Remove one screw that secure the LCD bracket.
8. Remove another screw holding the LCD bracket on the other side.
9. Then detach the LCD panel from the LCD cover carefully.



10. Remove the two screws holding the right bracket.
11. Then remove the right bracket.
12. Remove another two screws that tighten the left bracket.



- 13.** Remove the left bracket as the picture shows.
- 14.** Tear off the tape fastening the LCD cable.
- 15.** Tear off the the LCD cable fastening the LCD cable, then remove it..



---

## ***Disassembling the External Modules***

### Disassembling the HDD Module

1. Remove the two screws holding the HDD bracket on one side.
2. Remove another two screws holding the HDD bracket on the other side.
3. Then take the hard disc drive out from the HDD bracket.



### ***Disassembling the Optical Drive Module***

1. Remove the four screws as the picture shows.
2. Remove the two screws that secure the optical disc drive and the ODD holder.

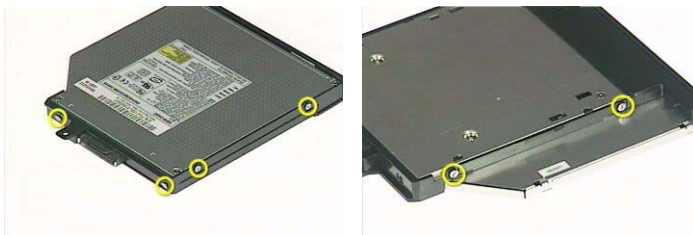

3. Push the ODD holder as shown.
4. Detach the ODD holder.
5. Disconnect the ODD connector board then remove it.

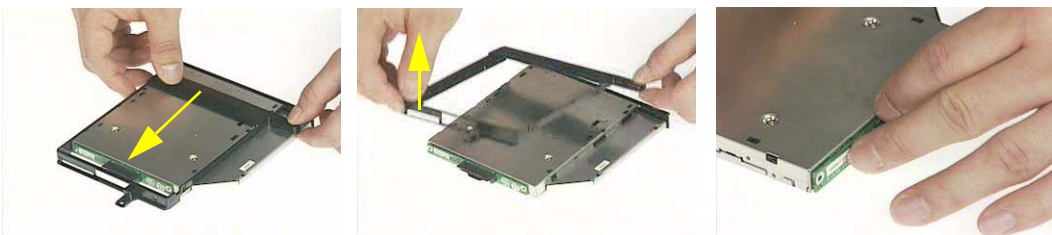

## *Troubleshooting*

---

Use the following procedure as a guide for computer problems.

**NOTE:** The diagnostic tests are intended to test only Acer products. Non-Acer products, prototype cards, or modified options can give false errors and invalid system responses.

1. Obtain the failing symptoms in as much detail as possible.
2. Verify the symptoms by attempting to re-create the failure by running the diagnostic test or by repeating the same operation.

---

# ***System Check Procedures***

## ***External Diskette Drive Check***

Do the following to isolate the problem to a controller, driver, or diskette. A write-enabled, diagnostic diskette is required.

**NOTE:** Make sure that the diskette does not have more than one label attached to it. Multiple labels can cause damage to the drive or cause the drive to fail.

Do the following to select the test device.

1. Boot from the diagnostics diskette and start the diagnostics program.
2. See if FDD Test is passed as the program runs to FDD Test.
3. Follow the instructions in the message window.

If an error occurs with the internal diskette drive, reconnect the diskette connector on the system board.

If the error still remains:

1. Reconnect the external diskette drive/DVD-ROM module.
2. Replace the external diskette drive/CD-ROM module.
3. Replace the main board.

## ***External CD-ROM Drive Check***

Do the following to isolate the problem to a controller, drive, or CD-ROM. Make sure that the CD-ROM does not have any label attached to it. The label can cause damage to the drive or can cause the drive to fail.

Do the following to select the test device:

1. Boot from the diagnostics diskette and start the diagnostics program.
2. See if CD-ROM Test is passed when the program runs to CD-ROM Test.
3. Follow the instructions in the message window.

If an error occurs, reconnect the connector on the System board. If the error still remains:

1. Reconnect the external diskette drive/CD-ROM module.
2. Replace the external diskette drive/CD-ROM module.
3. Replace the main board.

## ***Keyboard or Auxiliary Input Device Check***

Remove the external keyboard if the internal keyboard is to be tested.

If the internal keyboard does not work or an unexpected character appears, make sure that the flexible cable extending from the keyboard is correctly seated in the connector on the system board.

If the keyboard cable connection is correct, run the Keyboard Test.

If the tests detect a keyboard problem, do the following one at a time to correct the problem. Do not replace a non-defective FRU:

1. Reconnect the keyboard cables.
2. Replace the keyboard.
3. Replace the main board.

The following auxiliary input devices are supported by this computer:

- Numeric keypad
- External keyboard

If any of these devices do not work, reconnect the cable connector and repeat the failing operation.

---

## ***Memory check***

Memory errors might stop system operations, show error messages on the screen, or hang the system.

1. Boot from the diagnostics diskette and start the doagmpstotics program (please refer to main board).
2. Go to the diagnostic memory in the test items.
3. Press F2 in the test items.
4. Follow the instructions in the message window.

**NOTE:** Make sure that the DIMM is fully installed into the connector. A loose connection can cause an error.

## ***Power System Check***

To verify the symptom of the problem, power on the computer using each of the following power sources:

1. Remove the battery pack.
2. Connect the power adapter and check that power is supplied.
3. Disconnect the power adapter and install the charged battery pack; then check that power is supplied by the battery pack.

If you suspect a power problem, see the appropriate power supply check in the following list:

- "Check the Power Adapter" on page 59
- "Check the Battery Pack" on page 60



---

## Check the Power Adapter

Unplug the power adapter cable from the computer and measure the output voltage at the plug of the power adapter cable. See the following figure

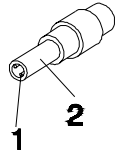

Pin 1: +19 to +20.5V  
Pin 2: 0V, Ground

1. If the voltage is not correct, replace the power adapter.
2. If the voltage is within the range, do the following:
  - Replace the System board.
  - If the problem is not corrected, see “Undetermined Problems” on page 70.
  - If the voltage is not correct, go to the next step.

**NOTE:** An audible noise from the power adapter does not always indicate a defect.

3. If the power-on indicator does not light up, check the power cord of the power adapter for correct continuity and installation.
4. If the operational charge does not work, see “Check the Battery Pack” on page 60.

---

## ***Check the Battery Pack***

To check the battery pack, do the following:

From Software:

1. Check out the Power Management in control Panel
2. In Power Meter, confirm that if the parameters shown in the screen for Current Power Source and Total Battery Power Remaining are correct.
3. Repeat the steps 1 and 2, for both battery and adapter.
4. This helps you identify first the problem is on recharging or discharging.

From Hardware:

1. Power off the computer.
2. Remove the battery pack and measure the voltage between battery terminals 1(+) and 6(ground). See the following figure

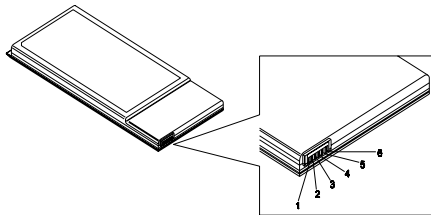

3. If the voltage is still less than 7.5 Vdc after recharging, replace the battery.

To check the battery charge operation, use a discharged battery pack or a battery pack that has less than 50% of the total power remaining when installed in the computer.

If the battery status indicator does not light up, remove the battery pack and let it return to room temperature. Re-install the battery pack.

If the charge indicator still does not light up, replace the battery pack. If the charge indicator still does not light up, replace the DC/DC charger board.

## ***Touchpad Check***

If the touchpad doesn't work, do the following actions one at a time to correct the problem. Do not replace a non-defective FRU:

1. Reconnect the touchpad cables.
2. Replace the touchpad.
3. Replace the system board.

After you use the touchpad, the pointer drifts on the screen for a short time. This self-acting pointer movement can occur when a slight, steady pressure is applied to the touchpad pointer. This symptom is not a hardware problem. No service actions are necessary if the pointer movement stops in a short period of time.

---

## ***Power-On Self-Test (POST) Error Message***

The POST error message index lists the error message and their possible causes. The most likely cause is listed first.

**NOTE:** Perform the FRU replacement or actions in the sequence shown in FRU/Action column, if the FRU replacement does not solve the problem, put the original part back in the computer. Do not replace a non-defective FRU.

This index can also help you determine the next possible FRU to be replaced when servicing a computer.

If the symptom is not listed, see “Undetermined Problems” on page 70.

The following lists the error messages that the BIOS displays on the screen and the error symptoms classified by function.

**NOTE:** Most of the error messages occur during POST. Some of them display information about a hardware device, e.g., the amount of memory installed. Others may indicate a problem with a device, such as the way it has been configured.

**NOTE:** If the system fails after you make changes in the BIOS Setup Utility menus, reset the computer, enter Setup and install Setup defaults or correct the error.

# Index of Error Messages

## Error Code List

Error Codes	Error Messages
006	Equipment Configuration Error Causes: 1. CPU BIOS Update Code Mismatch 2. IDE Primary Channel Master Drive Error (The causes will be shown before "Equipment Configuration Error")
010	Memory Error at xxxx:xxxx:xxxxh (R:xxxxh, W:xxxxh)
070	Real Time Clock Error
071	CMOS Battery Bad
072	CMOS Checksum Error
110	System disabled. Incorrect password is specified.
<No error code>	Battery critical LOW In this situation BIOS will issue 4 short beeps then shut down system, no message will show.
<No error code>	Thermal critical High In this situation BIOS will shut down system, not show message.

## Error Message List

Error Messages	FRU/Action in Sequence
Failure Fixed Disk	Reconnect hard disk drive connector. "Load Default Settings" in BIOS Setup Utility. Hard disk drive System board
Stuck Key	see "Keyboard or Auxiliary Input Device Check" on page 57.
Keyboard error	see "Keyboard or Auxiliary Input Device Check" on page 57.
Keyboard Controller Failed	see "Keyboard or Auxiliary Input Device Check" on page 57.
Keyboard locked - Unlock key switch	Unlock external keyboard
Monitor type does not match CMOS - Run Setup	Run "Load Default Settings" in BIOS Setup Utility.
Shadow RAM Failed at offset: nnnn	BIOS ROM System board
System RAM Failed at offset: nnnn	DIMM System board
Extended RAM Failed at offset: nnnn	DIMM System board
System battery is dead - Replace and run Setup	Replace RTC battery and Run BIOS Setup Utility to reconfigure system time, then reboot system.
System CMOS checksum bad - Default configuration used	RTC battery Run BIOS Setup Utility to reconfigure system time, then reboot system.
System timer error	RTC battery Run BIOS Setup Utility to reconfigure system time, then reboot system. System board

## Error Message List

Error Messages	FRU/Action in Sequence
Real time clock error	RTC battery Run BIOS Setup Utility to reconfigure system time, then reboot system. System board
Previous boot incomplete - Default configuration used	Run "Load Default Settings" in BIOS Setup Utility. RTC battery System board
Memory size found by POST differed from CMOS	Run "Load Default Settings" in BIOS Setup Utility. DIMM System board
Diskette drive A error	Check the drive is defined with the proper diskette type in BIOS Setup Utility See "External Diskette Drive Check" on page 57.
Incorrect Drive A type - run SETUP	Check the drive is defined with the proper diskette type in BIOS Setup Utility
System cache error - Cache disabled	System board
CPU ID:	System board
DMA Test Failed	DIMM System board
Software NMI Failed	DIMM System board
Fail-Safe Timer NMI Failed	DIMM System board
Device Address Conflict	Run "Load Default Settings" in BIOS Setup Utility. RTC battery System board
Allocation Error for device	Run "Load Default Settings" in BIOS Setup Utility. RTC battery System board
Failing Bits: nnnn	DIMM BIOS ROM System board
Fixed Disk n	None
Invalid System Configuration Data	BIOS ROM System board
I/O device IRQ conflict	Run "Load Default Settings" in BIOS Setup Utility. RTC battery System board
Operating system not found	Enter Setup and see if fixed disk and drive A: are properly identified. Diskette drive Hard disk drive System board

## Error Message List

No beep Error Messages	FRU/Action in Sequence
No beep, power-on indicator turns off and LCD is blank.	Power source (battery pack and power adapter). See "Power System Check" on page 58. Ensure every connector is connected tightly and correctly. Reconnect the DIMM. LED board. System board.
No beep, power-on indicator turns on and LCD is blank.	Power source (battery pack and power adapter). See "Power System Check" on page 58. Reconnect the LCD connector Hard disk drive LCD inverter ID LCD cable LCD Inverter LCD System board
No beep, power-on indicator turns on and LCD is blank. But you can see POST on an external CRT.	Reconnect the LCD connectors LCD inverter ID LCD cable LCD inverter LCD System board
No beep, power-on indicator turns on and a blinking cursor shown on LCD during POST.	Ensure every connector is connected tightly and correctly System board
No beep during POST but system runs correctly.	Speaker System board

---

## *POST Code*

<b>Code</b>	<b>Beeps</b>	<b>For Boot Block in Flash ROM</b>
E0h		Initialize the chipset
E1h		Initialize the bridge
E2h		Initialize the CPU
E3h		Initialize the system timer
E4h		Initialize system I/O
E5h		Check force recovery boot
E6h		Checksum BIOS ROM
E7h		Go to BIOS
E8h		Set Huge Segment
E9h		Initialize Multi Processor
EAh		Initialize OEM special code
EBh		Initialize PIC and DMA
ECh		Initialize Memory type
EDh		Initialize Memory size
EEh		Shadow Boot Block
EFh		System memory test
F0h		Initialize interrupt vectors
F1h		Initialize Run Time Clock
F2h		Initialize video
F3h		Initialize System Management Mode
F4h	1	Output one beep before boot
F5h		Boot to Mini DOS
F6h		Clear Huge Segment
F7h		Boot to Full DOS

# Index of Symptom-to-FRU Error Message

## LCD-Related Symptoms

Symptom / Error	Action in Sequence
LCD backlight doesn't work LCD is too dark LCD brightness cannot be adjusted LCD contrast cannot be adjusted	Enter BIOS Utility to execute "Load Setup Default Settings", then reboot system. Reconnect the LCD connectors. Keyboard (if contrast and brightness function key doesn't work). LCD inverter ID LCD cable LCD inverter LCD System board
Unreadable LCD screen Missing pels in characters Abnormal screen Wrong color displayed	Reconnect the LCD connector LCD inverter ID LCD cable LCD inverter LCD System board
LCD has extra horizontal or vertical lines displayed.	LCD inverter ID LCD inverter LCD cable LCD System board

## Indicator-Related Symptoms

Symptom / Error	Action in Sequence
Indicator incorrectly remains off or on, but system runs correctly	Reconnect the inverter board Inverter board System board

## Power-Related Symptoms

Symptom / Error	Action in Sequence
Power shuts down during operation	Power source (battery pack and power adapter). See "Power System Check" on page 58. Battery pack Power adapter Hard drive & battery connection board System board
The system doesn't power-on.	Power source (battery pack and power adapter). See "Power System Check" on page 58. Battery pack Power adapter Hard drive & battery connection board System board
The system doesn't power-off.	Power source (battery pack and power adapter). See "Power System Check" on page 58. Hold and press the power switch for more than 4 seconds. System board
Battery can't be charged	See "Check the Battery Pack" on page 60. Battery pack System board



### PCMCIA-Related Symptoms

Symptom / Error	Action in Sequence
System cannot detect the PC Card (PCMCIA)	PCMCIA slot assembly System board
PCMCIA slot pin is damaged.	PCMCIA slot assembly

### Memory-Related Symptoms

Symptom / Error	Action in Sequence
Memory count (size) appears different from actual size.	Enter BIOS Setup Utility to execute "Load Default Settings, then reboot system. DIMM System board

### Speaker-Related Symptoms

Symptom / Error	Action in Sequence
In Windows, multimedia programs, no sound comes from the computer.	Audio driver Speaker System board
Internal speakers make noise or emit no sound.	Speaker System board

### Power Management-Related Symptoms

Symptom / Error	Action in Sequence
The system will not enter hibernation	Keyboard (if control is from the keyboard) Hard disk drive System board
The system doesn't enter hibernation mode and four short beeps every minute.	See "Hibernation Mode" on page 34. Press Fn+F4 and see if the computer enters hibernation mode. Touchpad Keyboard Hard disk connection board Hard disk drive System board
The system doesn't enter standby mode after closing the LCD	See "Hibernation Mode" on page 34. LCD cover switch System board
The system doesn't resume from hibernation mode.	See "Hibernation Mode" on page 34. Hard disk connection board Hard disk drive System board
The system doesn't resume from standby mode after opening the LCD.	See "Hibernation Mode" on page 34. LCD cover switch System board
Battery fuel gauge in Windows doesn't go higher than 90%.	Remove battery pack and let it cool for 2 hours Refresh battery (continue use battery until power off, then charge battery) Battery pack System board

### Power Management-Related Symptoms

Symptom / Error	Action in Sequence
System hangs intermittently.	Reconnect hard disk/CD-ROM drives. Hard disk connection board System board

### Peripheral-Related Symptoms

Symptom / Error	Action in Sequence
System configuration does not match the installed devices.	Enter BIOS Setup Utility to execute "Load Default Settings", then reboot system. Reconnect hard disk/CD-ROM/diskette drives.
External display does not work correctly.	Press Fn+F5, LCD/CRT/Both display switching System board
USB does not work correctly	System board
Print problems.	Ensure the "Parallel Port" in the "Onboard Devices Configuration" of BIOS Setup Utility is set to Enabled. Onboard Devices Configuration Run printer self-test. Printer driver Printer cable Printer System Board
Serial or parallel port device problems.	Ensure the "Serial Port" in the Devices Configuration" of BIOS Setup Utility is set to Enabled. Device driver Device cable Device System board

### Keyboard/Touchpad-Related Symptoms

Symptom / Error	Action in Sequence
Keyboard (one or more keys) does not work.	Reconnect the keyboard cable. Keyboard System board
Touchpad does not work.	Reconnect touchpad cable. Touchpad board System board

### Modem-Related Symptoms

Symptom / Error	Action in Sequence
Internal modem does not work correctly.	Modem phone port modem combo board System board

**NOTE:** If you cannot find a symptom or an error in this list and the problem remains, see "Undetermined Problems" on page 70.

---

## ***Intermittent Problems***

Intermittent system hang problems can be caused by a variety of reasons that have nothing to do with a hardware defect, such as: cosmic radiation, electrostatic discharge, or software errors. FRU replacement should be considered only when a recurring problem exists.

When analyzing an intermittent problem, do the following:

1. Run the advanced diagnostic test for the system board in loop mode at least 10 times.
2. If no error is detected, do not replace any FRU.
3. If any error is detected, replace the FRU. Rerun the test to verify that there are no more errors.

---

## ***Undetermined Problems***

The diagnostic problems does not identify which adapter or device failed, which installed devices are incorrect, whether a short circuit is suspected, or whether the system is inoperative.

Follow these procedures to isolate the failing FRU (do not isolate non-defective FRU).

**NOTE:** Verify that all attached devices are supported by the computer.

**NOTE:** Verify that the power supply being used at the time of the failure is operating correctly. (See “Power System Check” on page 58):

1. Power-off the computer.
2. Visually check them for damage. If any problems are found, replace the FRU.
3. Remove or disconnect all of the following devices:
  - Non-Acer devices
  - Printer, mouse, and other external devices
  - Battery pack
  - Hard disk drive
  - DIMM
  - CD-ROM/Diskette drive Module
  - PC Cards
4. Power-on the computer.
5. Determine if the problem has changed.
6. If the problem does not recur, reconnect the removed devices one at a time until you find the failing FRU.
7. If the problem remains, replace the following FRU one at a time. Do not replace a non-defective FRU:
  - System board
  - LCD assembly

---

# Use NAPP CD to Build Master Hard Disc Drive

## CD to Disk Recovery

1. Prepare NAPP CD, Recovery CD and System CD.
2. Put NAPP CD into the optical drive. Then boot up the system.
3. The system will ask you if you want to build NAPP Master HDD. Please press any key to continue.



4. NAPP CD will start to preload the system, please click [Y].



- 
5. Select CD to Disk Recovery.

```
Method Selector
=====
1. Disk To Disk Recovery
2. CD to Disk Recovery
X. Quit

Please select your Choose...[1,2,x]?
```

6. Put the Recovery CD to the optical drive. This step is to create image files to the system, you do not have to put the Recovery CD to the optical drive in order. Place one Recovery CD to the drive at one time till you finish all Recovery CDs.

```
Please Insert Any Recovery CD

Please Press Any Key to Continue.
Press any key to continue...
_
```

After you place the Recovery CD to the optical drive, you will see the display below.

---

```
Please Wait for COPYING .....  
X:\images \70E40101.HDD
```

7. Then insert the System CD to the optical drive.

```
Please Insert the System CD  
  
Please Press Any Key to Continue.  
Press any key to continue...  
_
```

8. You will see the screen displaying "PASS" when the system has built NAPP Master hard disc drive.



## Disk to Disk Recovery

1. Prepare NAPP CD, Recovery CD and System CD.
2. Put NAPP CD into the optical drive. Then boot up the system.
3. The system will ask you if you want to build NAPP Master HDD. Please press any key to continue.



4. NAPP CD will start to preload the system, please click [Y].



```
Acer NAPP Preload Selector for Acer System Version 1.4.0.1
Copyright 2003 Acer Inc.

=====

This will preload your system. Are you sure?[Y,N]?
```

- 5. Select Disk to Disk Recovery. Then choose Single Language or Multi-Languages Recovery.  
**NOTE:** For Multi-Languages Recovery, not more than five languages could be loaded to the system.

```
Method Selector
=====
1. Single Language Recovery
2. Multi-Languages Recovery
X. Quit

Please select your Choose...[1,2,x]?
```

- 6. Put the Recovery CD to the optical drive. This step is to create image files to the system, you do not have to put the Recovery CD to the optical drive in order. Place one Recovery CD to the drive at one time till you finish all Recovery CDs.

---

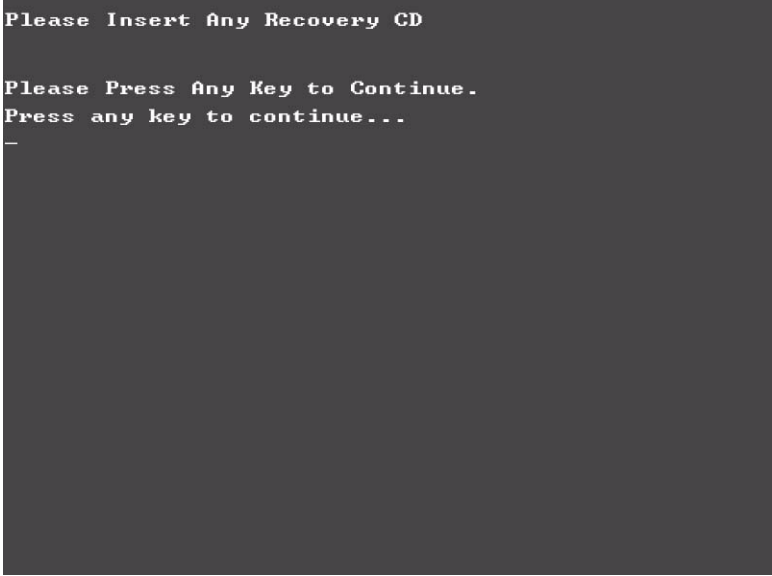

```
Please Insert Any Recovery CD

Please Press Any Key to Continue.
Press any key to continue...
_
```

After you place the Recovery CD to the optical drive, you will see the display below.



```
Please Wait for COPYING .....
X:\images \70E40I01.HDD
```

7. Then insert the System CD to the optical drive.

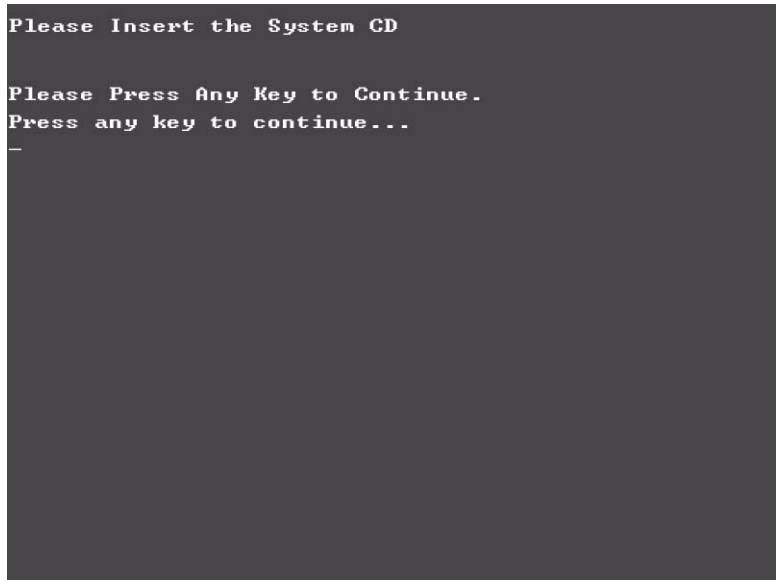

- 8. You will see the screen displaying “PASS” when the system has buit NAPP Master hard disc drive.



## Jumper and Connector Locations

### Top View

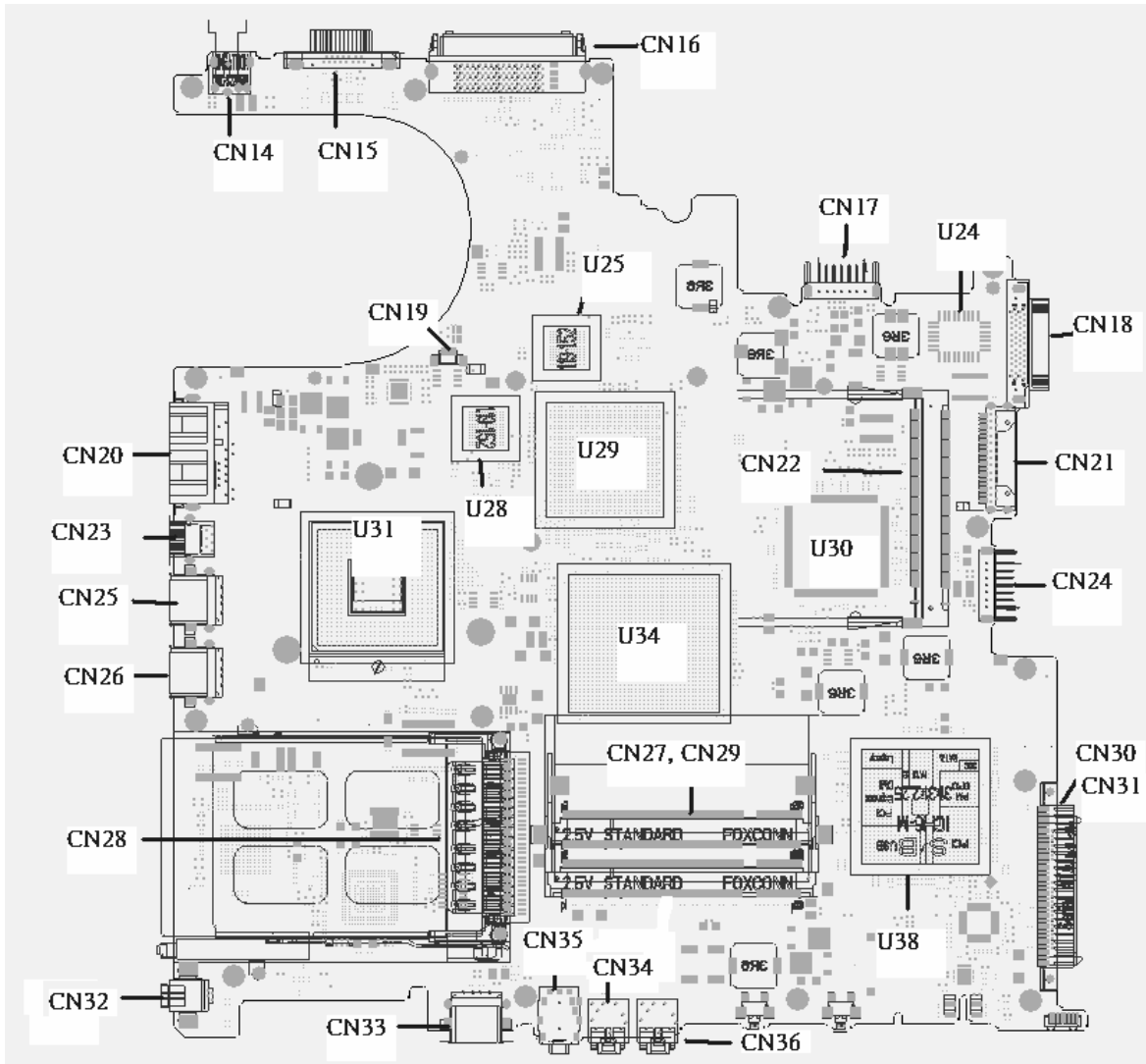

**Rear View**

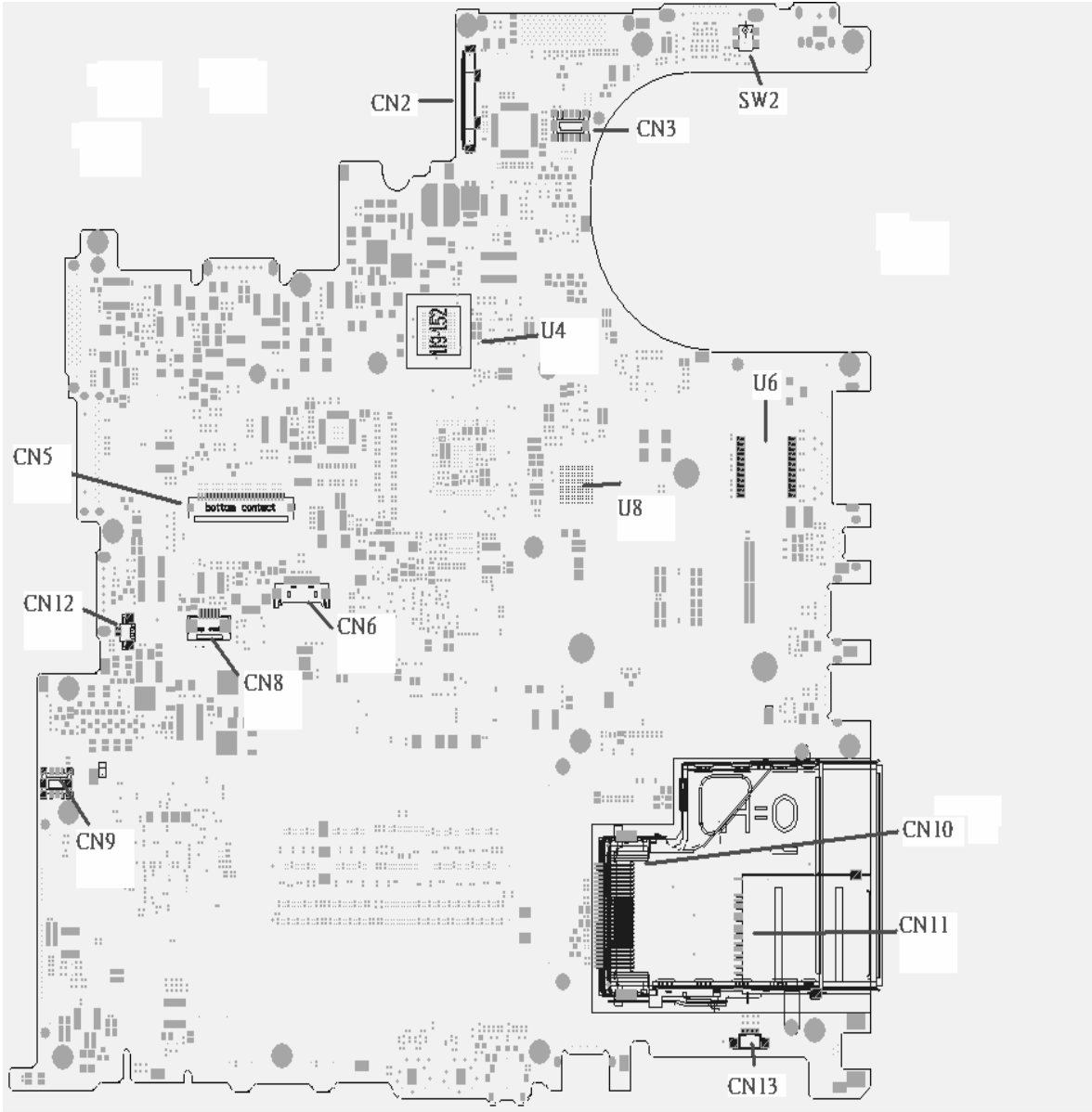

ITEM	DESCRIPTION	ITEM	DESCRIPTION
CN2	LCD Connector	CN14	DC JACK
CN3	LED board connector	CN15	CRT connector
SW2	Lid switch	CN16	Docking connector
CN10	express card connector	CN17	Battery connector
CN11	4 IN 1 connector	CN18	Fix ODD connector
CN13	Speaker connector	CN21	Swap ODD connector
CN9	MD board connector	CN24	2nd Battery connector
CN12	INT MIC connector	CN30	PATA HDD connector
CN5	Keyboard connector	CN31	SATA HDD connector
CN6	BT connector	CN36	Line IN connector
CN8	TP connector	CN34	MIC IN connector
U4	VGA RAM	CN35	Line out/SPDIF connector
U8	VGA RAM	CN33	USB connector
U6	LAN transformer	CN32	1394 connector
CN28	PCMCIA connector	CN26	USB connector
CN25	USB connector	CN23	S video connector
CN20	RJ45/RJ11 connector	CN19	Fan connector
CN22	MINI PCI connector	U31	CPU
U30	EC	U29	VGA Chp
U34	North Bridge	U38	South Bridge
U25	VGA RAM	U28	VGA RAM
U24	BIOS ROM		

# RTC Jumper

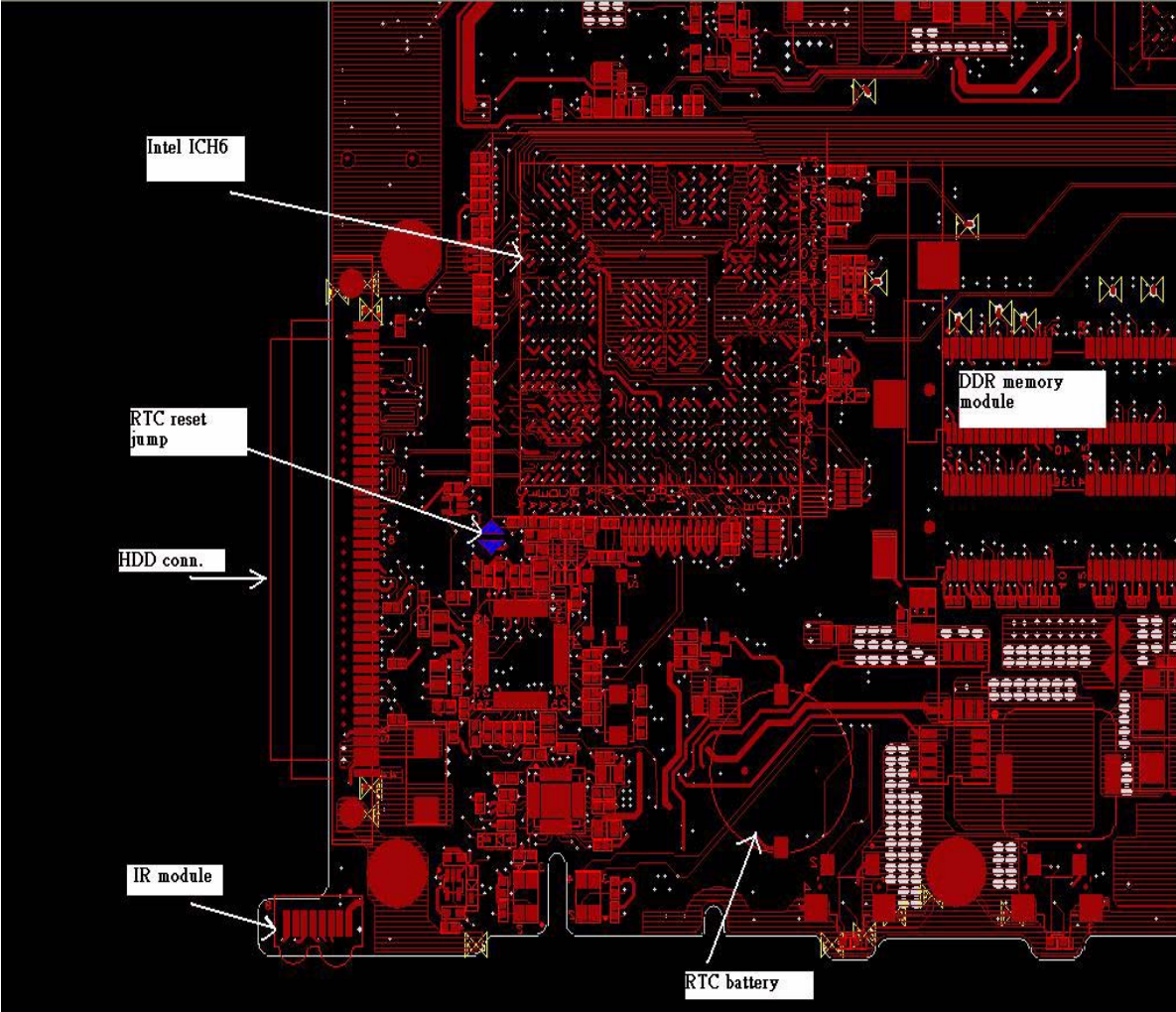

## ***FRU (Field Replaceable Unit) List***

---

This chapter gives you the FRU (Field Replaceable Unit) listing in global configurations of Aspire 5510. Refer to this chapter whenever ordering for parts to repair or for RMA (Return Merchandise Authorization).

Please note that WHEN ORDERING FRU PARTS, you should check the most up-to-date information available on your regional web or channel. For whatever reasons a part number change is made, it will not be noted on the printed Service Guide. For ACER AUTHORIZED SERVICE PROVIDERS, your Acer office may have a DIFFERENT part number code from those given in the FRU list of this printed Service Guide. You MUST use the local FRU list provided by your regional Acer office to order FRU parts for repair and service of customer machines.

**NOTE:** To scrap or to return the defective parts, you should follow the local government ordinance or regulations on how to dispose it properly, or follow the rules set by your regional Acer office on how to return it.



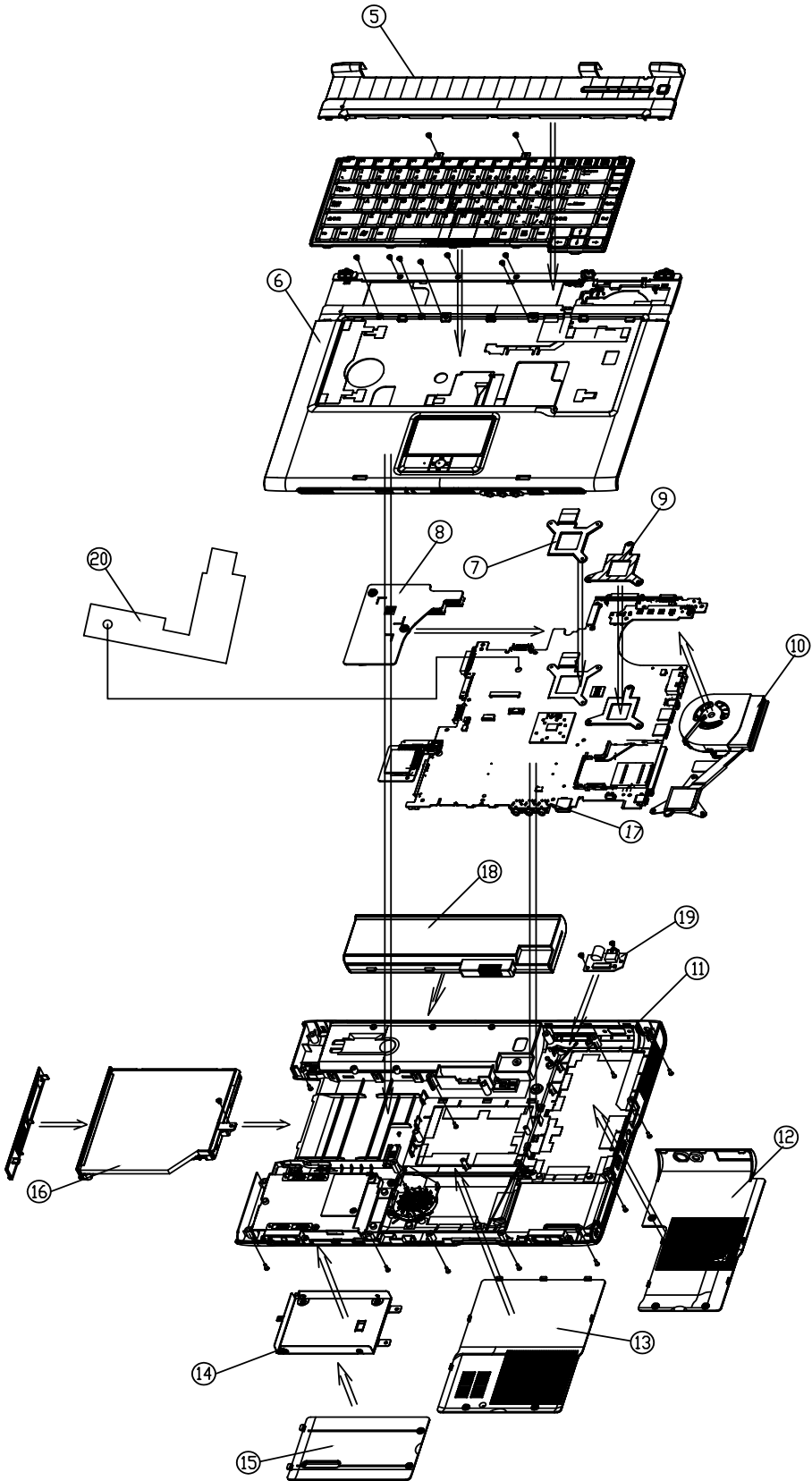

# Exploded Diagram

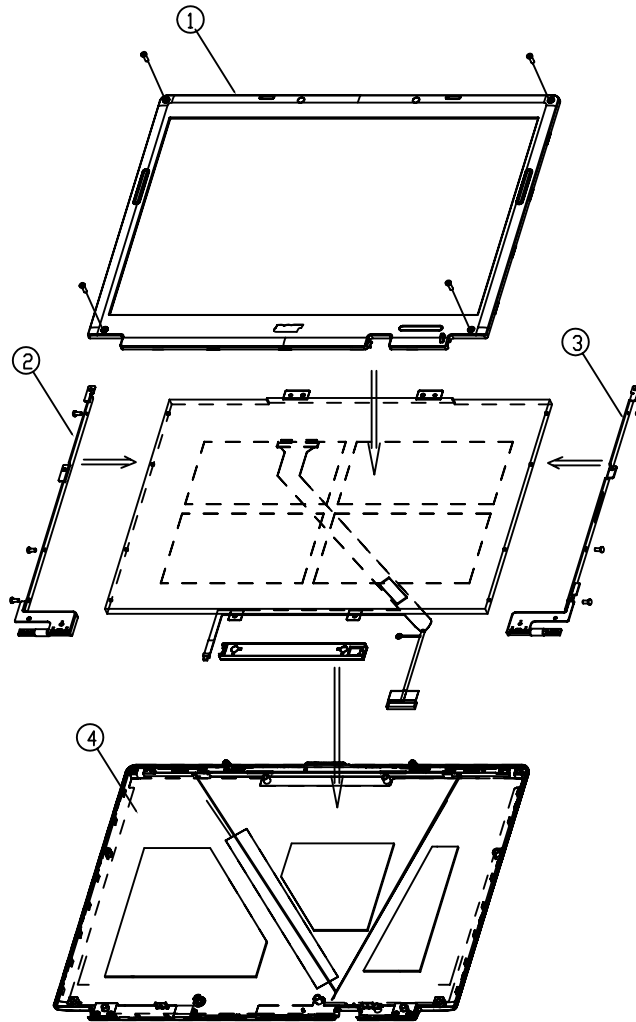





Item	Description	Item	Description
1	LCD bezel	11	Lower case without media bay
2	LCD hinge(left)	12	CPU cover w/ TV tuner assy
3	LCD hinge(right)	13	DDR cover
4	LCD cover	14	HDD bracket
5	Middle cover	15	HDD cover
6	Upper case	16	DVD dual assy
7	VGA support plate	17	Mainboard C/S CIR only
8	VGA sink	18	Battery
9	CPU support	19	TV tuner board
10	M29 thermal module	20	Mainboard mylar

**Parts**

Illustration	Part Name	Description	Acer P/N
<b>Adapter</b>			
	ADAPTER 65W 3 PIN DELTA SADP-65KB BFD	ZL2 ADAPTER DELTA S.P.	AP.06501.005
	ADAPTER 65W 3 PIN LITE-ON PA-1650-02 Q2 19V	ZL2 ADAPTER LITE-ON S.P.	AP.06503.006
	ADAPTER 65W 3 PIN HIPRO HP-OK066B13QT	ZL2 ADAPTER HIPRO S.P.	AP.06506.001
<b>Battery</b>			
	BATTERY SANYO LI-ION 4S2P 4.4A 4UR18650F-2- QC140	ZL1A BATTERY (SANYO 8 CELL) S.P.	BT.T5003.001
	BATT LI LIP8198QUPC SY6(ZL3,4S2P,4.4A)LF	ZL3 BATTERY (SONY 8 CELL) S/P	BT.00804.008
	BATT LI LIP4081QUPC SY6(ZL5,4S1P,2.2A)LF	ZL7 BATTERY (SONY 4 CELL) S/P	BT.00404.003
	BATTERY SANYO LI-ION 4S1P 2.2A 4UR18650F-2- QC141	ZL1B BATTERY (SANYO 4 CELL) S.P.	BT.T5003.002
<b>Board</b>			
	WIRELESS LAN BOARD FOXCONN ABT_ATH5413BG	ZL7 WIRELESS LAN CARD(MINIPCI) T60N874.03 LF S/P	54.A76V7.001
	BLUETOOTH MODULE W/ANTENNA	ZA1 BLUETOOTH MODULE S/P (WITH BT ANTENNA)	54.T48V7.001
	WIRELESS LAN BOARD (802.11b+g) INTEL	ZG1S 802.11b+g SPARE PART-Intel	KI.CAX01.008
	LAUNCH BOARD	ZL1A LEB BOARD ASY S.P.	55.T50V7.001

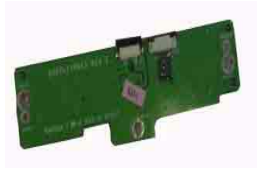
**Parts**

Illustration	Part Name	Description	Acer P/N
	TOUCH PAD BOARD	ZL3 TOUCH PAD BOARD ASSY S.P.	55.A65V7.001
Cable			
	FFC CABLE - TP/B TO MB	ZL1A TOUCH PAD BOARD M/B (FFC) ASSY S.P.	50.T50V7.001
	MODEM CABLE	ZL1A MODEM CABLE ASSY S.P.	50.T50V7.002
	POWER CORD US (3 PIN)	ET2S POWER CORD S/ P-US	27.A03V7.001
	POWER CORD PRC (3 PIN)	ET2S POWER CORD S/ P-PRC	27.A03V7.003
	POWER CORD KOERA (3 Pin)	ZI1S POWER CORD SPARE PART-KOERA	27.T23V7.006
	POWER CORD EU (3 PIN)	ET2S POWER CORD S/ P-EU	27.A03V7.002
	POWER CORD UK (3 PIN)	ET2S POWER CORD S/ P-UK	27.A03V7.004
	POWER CORD ITALIAN (3 PIN)	ET2S POWER CORD S/ P-ITALIAN	27.A03V7.005
	POWER CORD- SWISS	ET2S POWER CORD SPARE PART-SWISS	27.A03V7.007
	POWER CORD AU (3 PIN)	ET2S POWER CORD S/ P-AU	27.A03V7.008
	POWER CORD DANISH (3 PIN)	ET2S POWER CORD S/ P-DANISH	27.A03V7.006
	POWER CORD AF (3 PIN)	ZI5 POWER CORD S/P-AF	27.T48V7.001
	POWER CORD AF-S (INDIA)	ZL6A POWER CORD S/P INDIA	27.A50V7.001
	POWER CORD ISRAEL (3 PIN)	ZL6A POWER CORD S/ P-ISR	27.A50V7.002
	POWER CORD AU W/ LABEL (3 PIN)	ZL6A POWER CORD S/ P-AU	27.A50V7.003
Case/Cover/Bracket Assembly			

Parts

Illustration	Part Name	Description	Acer P/N
	MIDDLE COVER W/ BUTTON	ZL1C K/B COVER (AS) S.P.	42.A27V7.001
	LOWER CASE W/ SPEAKER	ZL7 BASE ASSY W/O MEDIA BAY S/P	60.A76V7.001
	UPPER CASE W/TP, TP BRACKET, MIC, BLUETOOTH CABLE	ZL2 TOP COVER AS ASSY CONDUCT PAINT S/P	60.A43V7.001
	DIMM/WIRELESS COVER	ZL7 DDR COVER ASSY S/P	42.T63V7.001
	HEATSINK COVER W/ DOCKING	ZL7 HEATSINK COVER W/O DOCKING W/TV S/P	42.A76V7.002
	3 IN 1 COVER	ZL2 3 IN 1 COVER ASSY S.P.	42.T63V7.003
	DUMMY BATTERY	ZL7 DUMMY BATTERY ASSY S/P	60.T50V7.010
	HDD COVER	ZL7 HDD COVER ASSY S/P	42.A76V7.001
	HDD BRACKET	ZL1A HDD BRACKET ASSY S.P.	33.T50V7.001
Communication Module			
Optical Disk Drive Module	WIRELESS LAN ANTENNA	ZL1A WIRELESS ANTENNA ASSY S.P.	50.T50V7.003

**Parts**

Illustration	Part Name	Description	Acer P/N
	DVD/CDRW COMBO MODULE PANASONIC UJDA-770 LF	ZL5 COMBO ASSY(UJDA770AC-A)	6M.TAGV7.002
	DVD/CDRW COMBO DRIVE PANASONIC UJDA-770 G BASE LF	ZL7 COMBO Panasonic MODULE ASSY S/P	KO.02406.013
	OPTICAL DEVICE HOLDER-FIX	ZL1A DVD HOLDER (FIX) ASSY S.P.	42.T51V7.003
	DVD/CDRW BEZEL FOR G-BASE	ZL7 COMBO BEZEL G-BASE ASSY S/P	42.A65V7.003
	DVD/CDRW COMBO MODULE 24X QSI SBW-243	ZL3 COM QSI SCB5265(PL)W/OMB ASSY S/P	6M.A65V7.004
	DVD/CDRW COMBO DRIVE 24X QSI SBW-243 G BASE	ZL3 COMBO QSISCB5265 PHILIP SBW-243 S/P	KO.02403.007
	OPTICAL DEVICE HOLDER-FIX	ZL1A DVD HOLDER (FIX) ASSY S.P.	42.T51V7.003
	DVD/CDRW BEZEL FOR G-BASE	ZL7 COMBO BEZEL G-BASE ASSY S/P	42.A65V7.003
	DVD DUAL MODULE PANASONIC UJ-840BAA2 G BASE	ZL5 DVD DUAL(UJ-840 BAA2) ASSY S/P	6M.A51V7.003
	DVD DUAL DRIVE PANASONIC UJ-840BAA2 D. LAYER G BASE	ZL2 DVD DUAL PIONEER (DVR-K15RA) S.P.	KU.00807.010
	OPTICAL DEVICE HOLDER-FIX	ZL1A DVD HOLDER (FIX) ASSY S.P.	42.T51V7.003
	DVD DUAL BEZEL G BASE	ZL1 DVD DUAL BEZEL ASSY W/P (GB) S/P	42.A51V7.005
	DVD DUAL MODULE PIONEER DVR-K15RA G BASE	ZL5 DVD DUALPIONEER (DVR-K15RA) ASSY S/P	6M.A51V7.002
	DVD DUAL DRIVEPIONEER DVR-K15RA D. LAYER G BASE	ZL2 DVD DUAL PIONEER (DVR-K15RA) S.P.	KU.00805.012
	OPTICAL DEVICE HOLDER-FIX	ZL1A DVD HOLDER (FIX) ASSY S.P.	42.T51V7.003
	DVD DUAL BEZEL G BASE	ZL1 DVD DUAL BEZEL ASSY W/P (GB) S/P	42.A51V7.005
	DVD DUAL MODULE LITE-ON SOSW-833 DL G BASE	ZL6 DVD DAUL (L/O,SOSW-833) ASSY S.P.	6M.T66V5.003
	DVD DUAL DRIVEPIONEER DVR-K15RA D. LAYER G BASE	ZL2 DVD DUAL PIONEER (DVR-K15RA) S.P.	KU.00805.012

**Parts**

Illustration	Part Name	Description	Acer P/N
	OPTICAL DEVICE HOLDER-FIX	ZL1A DVD HOLDER (FIX) ASSY S/P.	42.T51V7.003
	DVD DUAL BEZEL G BASE	ZL1 DVD DUAL BEZEL ASSY W/P (GB) S/P	42.A51V7.005
	DVD KME SUPMU ASS W/P W/O MB	ZL2 KME SUPMU ASS W/P W/O MB STN B/S S/P	6M.A76V7.001
	DVD SUP MUL DRIVE KME UJ-840BAA-A	ZL7 DVD SUP MUL UJ-840BAA-A S/P	KU.00807.011
	OPTICAL DEVICE HOLDER-FIX	ZL1A DVD HOLDER (FIX) ASSY S/P.	42.T51V7.003
	DVD SUPER MULTI BEZEL G BASE	ZL2 SUPER MULTI BEZEL (HLDS)W/P S/P	42.A65V7.002
	DVD DUAL MODUEL PHILIPS	ZL7 QSI DUAL ASSY W/P W/O MB S/P	6M.A76V7.002
	DVD/RW DUAL PHILIPS SDVD8441 ( QSI SDW-082K)	ZL7 DVD RW(DUAL) SDVD8441 L-F S/P	KU.00803.006
	OPTICAL DEVICE HOLDER-FIX	ZL1A DVD HOLDER (FIX) ASSY S/P.	42.T51V7.003
	DVD DUAL BEZEL G BASE	ZL1 DVD DUAL BEZEL ASSY W/P (GB) S/P	42.A51V7.005
	DVD DVD DAUL MODULE KME UJ-845 DL SLOT IN		6M.A65V7.002
	DVD DVD DUAL DRIVE KME UJ-845 DL SLOT IN		KU.00807.015
	OPTICAL DEVICE HOLDER		42.T51V7.003
	DVD DVD DUAL BEZEL FOR KME SLOT IN		42.T63V7.005
	DVD DUAL MODUEL PIONEER	ZL2 PIO DVD DUAL ASS W/P W/O MB(SLOT)B/S S/P	6M.A65V7.003
	DVD DUAL DRIVER PIONEER K05RA	ZL3 DVD DUAL (K05RA) SLOT-IN S/P	KU.00805.013
	OPTICAL DEVICE HOLDER-FIX	ZL1A DVD HOLDER (FIX) ASSY S/P.	42.T51V7.003
	DVD DUAL BEZEL FOR PIONEER SLOT IN	ZL3 SLOT BEZEL ( PIO ) ASSY S/P	42.A63V7.003
HDD/Hard Disk Drive			
	40G SEAGATE 2.5 IN. 4200RPM N2.2ST9402112A F/ W:3.01		KH.04001.014
	40G TOSHIBA 2.5 IN. 4200RPM PLUTO MK4025GAS (ROHS) F/ W KA100A		KH.04004.005

**Parts**

Illustration	Part Name	Description	Acer P/N
	40G HGST 2.5 IN. 4.2RPM MORAGA+HTS424040M 9AT00 13G1132 F/ W:A71A		KH.04007.012
	40G HGST 2.5 IN. 4200RPM HAKONA-A F/ W :A70G		KH.04007.013
	60G SEAGATE 2.5 IN. 4200RPM N2.2ST960812A F/ W:3.01		KH.06001.003
	60G TOSHIBA 2.5 IN. 4200RPM PLUTO MK6025GAS (ROHS) F/ W KA200		KH.06004.004
	HGST MORAGA 60G 4200RPM IC25N020ATMR04-0 08K0634 F/W:AD4A		KH.06007.006
	60G HGST 2.5 IN. 4200RPM HAKONE-A F/ W :A70G		KH.06007.009
	80G SEAGATE 2.5 IN. 4200RPM N2.2ST980829A F/ W:3.01		KH.08001.013
	80G TOSHIBA 2.5 IN. 4200RPM PLUTO MK8025GAS (ROHS) F/ W KA023		KH.08004.003
	HGST 80G MORAGA 4200RPM IC25N0 80ATMR04-0 08K635 FW:AD4A		KH.08007.007
	80G HGST 2.5 IN. 4200RPM HAKONE-A F/ W:A70G		KH.08007.011
	100G SEAGATE 2.5 IN. 4200RPM N2.2ST9100825A F/ W:3.01		KH.10001.003
	100G TOSHIBA 2.5 IN. 4200RPM ARES MK1031GAS (ROHS) F/ W AA204A		KH.10004.001
Keyboard			
	AS1680/AS1410 KEYBOARD DARFON US International		KB.A2707.001
	AS1680/AS1410 KEYBOARD DARFON Chinese		KB.A2707.002
	AS1680/AS1410 KEYBOARD DARFON Spanish		KB.A2707.003



**Parts**

Illustration	Part Name	Description	Acer P/N
	AS1680/AS1410 KEYBOARD DARFON Thai		KB.A2707.004
	AS1680/AS1410 KEYBOARD DARFON Brazilian Protugese		KB.A2707.005
	AS1680/AS1410 KEYBOARD DARFON Korea		KB.A2707.006
	AS1680/AS1410 KEYBOARD DARFON UK		KB.A2707.007
	AS1680/AS1410 KEYBOARD DARFON German		KB.A2707.008
	AS1680/AS1410 KEYBOARD DARFON Italian		KB.A2707.009
	AS1680/AS1410 KEYBOARD DARFON French		KB.A2707.010
	AS1680/AS1410 KEYBOARD DARFON Swiss/G		KB.A2707.011
	AS1680/AS1410 KEYBOARD DARFON Portuguese		KB.A2707.012
	AS1680/AS1410 KEYBOARD DARFON Arabic		KB.A2707.013
	AS1680/AS1410 KEYBOARD DARFON Belgium		KB.A2707.014
	AS1680/AS1410 KEYBOARD DARFON Sweden		KB.A2707.015
	AS1680/AS1410 KEYBOARD DARFON Czech		KB.A2707.016
	AS1680/AS1410 KEYBOARD DARFON Hungaian		KB.A2707.017
	AS1680/AS1410 KEYBOARD DARFON Norway		KB.A2707.018
	AS1680/AS1410 KEYBOARD DARFON Danish		KB.A2707.019
	AS1680/AS1410 KEYBOARD DARFON Turkish		KB.A2707.020
	AS1680/AS1410 KEYBOARD DARFON Canadian French		KB.A2707.021

**Parts**

Illustration	Part Name	Description	Acer P/N
	AS1680/AS1410 KEYBOARD DARFON Japanese		KB.A2707.022
	AS1680/AS1410 KEYBOARD DARFON Greek		KB.A2707.023
	AS1680/AS1410 KEYBOARD DARFON Hebrew		KB.A2707.024
	AS1680/AS1410 KEYBOARD DARFON Russian		KB.A2707.025

Illustraion	Item	Description	Acer P/N
LCD			
	LCD MODULE 15.4 IN. WXGA GLARE LPL LP154W01-TLB5 LF		6M.A76V7.011
	LCD 15.4 IN. WXGA GLARE LPL LP154W01- TLB5 LF		LK.15408.012
	LCD INVERTER BOARD	ZL3 LCD INVERTER ASSY S/P	19.A50V7.001
	LCD BRACKET W/HINGE 15.4 IN. - L	ZL1A 15.4 IN. LCD HINGE (L) ASSY S.P.	33.T50V7.004
	LCD BRACKET W/HINGE 15.4 IN. - R	ZL1A 15.4 IN. LCD HINGE (R) ASSY S.P.	33.T50V7.005
	LCD CABLE - 15.4 IN. WXGA LF	ZL2 15 IN. WXGA CABLE L- F ASSY S/P	50.T50V7.006
	LCD PANEL W/LOGO W/ ANTENNA 15.4 IN.	ZL3D 15.4 IN. LCD COVER (AS) W/ANTENNA ASSY S/ P	60.A27V7.003
	LCD BEZEL W/RUBBER PAD 15.4 IN.	ZL1A 15.4 IN. LCD BEZEL ASSY S.P.	60.T50V7.006

Illustration	Item	Description	Acer P/N
	LCD MODULE 15.4 IN. WXGA GLARE QDI QD15TL07-02	ZL7 LCD UMA QDI(15.4WXGA)AS (GLARE) S/P	6M.A76V7.012
	LCD 15.4 IN. WXGA GLARE QDI QD15TL07-02	ZL7 LCD 15.4"(WXGA)QD15TL07 REV.02 LF S/P	LK.15409.009
	LCD INVERTER BOARD	ZL3 LCD INVERTER ASSY S/P	19.A50V7.001
	LCD BRACKET W/HINGE 15.4 IN. - L	ZL1A 15.4 IN. LCD HINGE (L) ASSY S.P.	33.T50V7.004
	LCD BRACKET W/HINGE 15.4 IN. - R	ZL1A 15.4 IN. LCD HINGE (R) ASSY S.P.	33.T50V7.005
	LCD CABLE - 15.4 IN. WXGA LF	ZL2 15 IN. WXGA CABLE L- F ASSY S/P	50.T50V7.006
	LCD PANEL W/LOGO W/ ANTENNA 15.4 IN.	ZL3D 15.4 IN. LCD COVER (AS) W/ANTENNA ASSY S/ P	60.A27V7.003
	LCD BEZEL W/RUBBER PAD 15.4 IN.	ZL1A 15.4 IN. LCD BEZEL ASSY S.P.	60.T50V7.006
	LCD MODULE 15.4 IN. WXGA GLARE CMO N15411-L0C	ZL2 LCD UMA ASSY CMO(15.4WXGA)AS B/S GLA S/P	6M.A76V7.013
	LCD 15.4 IN. WXGA GLARE CMO N15411-L0C	ZL7 LCD15.4(WXGA) N15411-L0C V0.0 B/S LF S/ P	LK.1540D.006
	LCD INVERTER BOARD	ZL3 LCD INVERTER ASSY S/P	19.A50V7.001
	LCD BRACKET W/HINGE 15.4 IN. - L	ZL1A 15.4 IN. LCD HINGE (L) ASSY S.P.	33.T50V7.004
	LCD BRACKET W/HINGE 15.4 IN. - R	ZL1A 15.4 IN. LCD HINGE (R) ASSY S.P.	33.T50V7.005
	LCD CABLE - 15.4 IN. WXGA LF	ZL2 15 IN. WXGA CABLE L- F ASSY S/P	50.T50V7.006
	LCD PANEL W/LOGO W/ ANTENNA 15.4 IN.	ZL3D 15.4 IN. LCD COVER (AS) W/ANTENNA ASSY S/ P	60.A27V7.003
	LCD BEZEL W/RUBBER PAD 15.4 IN.	ZL1A 15.4 IN. LCD BEZEL ASSY S.P.	60.T50V7.006

Illustration	Item	Description	Acer P/N
	LCD MODULE 15.4 IN. WXGA GLARE AU B154EW01 V8 LF		6M.A76V7.014
	LCD 15.4 IN. WXGA GLARE AU B154EW01 V8 LF		LK.15405.005
	LCD INVERTER BOARD	ZL3 LCD INVERTER ASSY S/P	19.A50V7.001
	LCD BRACKET W/HINGE 15.4 IN. - L	ZL1A 15.4 IN. LCD HINGE (L) ASSY S.P.	33.T50V7.004
	LCD BRACKET W/HINGE 15.4 IN. - R	ZL1A 15.4 IN. LCD HINGE (R) ASSY S.P.	33.T50V7.005
	LCD CABLE - 15.4 IN. WXGA LF	ZL2 15 IN. WXGA CABLE L- F ASSY S/P	50.T50V7.006
	LCD PANEL W/LOGO W/ ANTENNA 15.4 IN.	ZL3D 15.4 IN. LCD COVER (AS) W/ANTENNA ASSY S/ P	60.A27V7.003
	LCD BEZEL W/RUBBER PAD 15.4 IN.	ZL1A 15.4 IN. LCD BEZEL ASSY S.P.	60.T50V7.006
	LCD MODULE 15.4 IN. WXGA GLARE LPL LP154W01-TLB5 LF W/O WIRELESS		6M.A76V7.021
	LCD 15.4 IN. WXGA GLARE LPL LP154W01- TLB5 LF		LK.15408.012
	LCD INVERTER BOARD	ZL3 LCD INVERTER ASSY S/P	19.A50V7.001
	LCD BRACKET W/HINGE 15.4 IN. - L	ZL1A 15.4 IN. LCD HINGE (L) ASSY S.P.	33.T50V7.004
	LCD BRACKET W/HINGE 15.4 IN. - R	ZL1A 15.4 IN. LCD HINGE (R) ASSY S.P.	33.T50V7.005
	LCD CABLE - 15.4 IN. WXGA LF	ZL2 15 IN. WXGA CABLE L- F ASSY S/P	50.T50V7.006
	LCD PANEL W/LOGO W/O ANTENNA 15.4 IN.	ZL1C 15.4 IN. LCD COVER (AS) W/O ANTENNA ASSY S.P.	60.A51V7.004
	LCD BEZEL W/RUBBER PAD 15.4 IN.	ZL1A 15.4 IN. LCD BEZEL ASSY S.P.	60.T50V7.006

Illustration	Item	Description	Acer P/N
	LCD MODULE 15.4 IN. WXGA GLARE QDI QD15TL07-02 W/O WIRELESS	ZL7 LCD QDI(15.4WXGA)AS W/O ANT(GLA) S/P	6M.A76V7.022
	LCD 15.4 IN. WXGA GLARE QDI QD15TL07-02	ZL7 LCD 15.4"(WXGA)QD15TL07 REV.02 LF S/P	LK.15409.009
	LCD INVERTER BOARD	ZL3 LCD INVERTER ASSY S/P	19.A50V7.001
	LCD BRACKET W/HINGE 15.4 IN. - L	ZL1A 15.4 IN. LCD HINGE (L) ASSY S.P.	33.T50V7.004
	LCD BRACKET W/HINGE 15.4 IN. - R	ZL1A 15.4 IN. LCD HINGE (R) ASSY S.P.	33.T50V7.005
	LCD CABLE - 15.4 IN. WXGA LF	ZL2 15 IN. WXGA CABLE L- F ASSY S/P	50.T50V7.006
	LCD PANEL W/LOGO W/O ANTENNA 15.4 IN.	ZL1C 15.4 IN. LCD COVER (AS) W/O ANTENNA ASSY S.P.	60.A51V7.004
	LCD BEZEL W/RUBBER PAD 15.4 IN.	ZL1A 15.4 IN. LCD BEZEL ASSY S.P.	60.T50V7.006
	LCD MODULE 15.4 IN. WXGA GLARE CMO N15411-L0C W/O WIRELESS	ZL7 LCD UMA CMO(15.4WXGA)AS W/O ANT(GLA) S/P	6M.A76V7.023
	LCD 15.4 IN. WXGA GLARE CMO N15411-L0C	ZL7 LCD15.4(WXGA) N15411-L0C V0.0 B/S LF S/ P	LK.1540D.006
	LCD INVERTER BOARD	ZL3 LCD INVERTER ASSY S/P	19.A50V7.001
	LCD BRACKET W/HINGE 15.4 IN. - L	ZL1A 15.4 IN. LCD HINGE (L) ASSY S.P.	33.T50V7.004
	LCD BRACKET W/HINGE 15.4 IN. - R	ZL1A 15.4 IN. LCD HINGE (R) ASSY S.P.	33.T50V7.005
	LCD CABLE - 15.4 IN. WXGA LF	ZL2 15 IN. WXGA CABLE L- F ASSY S/P	50.T50V7.006
	LCD PANEL W/LOGO W/O ANTENNA 15.4 IN.	ZL1C 15.4 IN. LCD COVER (AS) W/O ANTENNA ASSY S.P.	60.A51V7.004
	LCD BEZEL W/RUBBER PAD 15.4 IN.	ZL1A 15.4 IN. LCD BEZEL ASSY S.P.	60.T50V7.006

Illustration	Item	Description	Acer P/N
	LCD MODULE 15.4 IN. WXGA GLARE AU B154EW01 V8 LF W/O WIRELESS		6M.A76V7.024
	LCD 15.4 IN. WXGA GLARE AU B154EW01 V8 LF		LK.15405.005
	LCD INVERTER BOARD	ZL3 LCD INVERTER ASSY S/P	19.A50V7.001
	LCD BRACKET W/HINGE 15.4 IN. - L	ZL1A 15.4 IN. LCD HINGE (L) ASSY S.P.	33.T50V7.004
	LCD BRACKET W/HINGE 15.4 IN. - R	ZL1A 15.4 IN. LCD HINGE (R) ASSY S.P.	33.T50V7.005
	LCD CABLE - 15.4 IN. WXGA LF	ZL2 15 IN. WXGA CABLE L-F ASSY S/P	50.T50V7.006
	LCD PANEL W/LOGO W/O ANTENNA 15.4 IN.	ZL1C 15.4 IN. LCD COVER (AS) W/O ANTENNA ASSY S.P.	60.A51V7.004
	LCD BEZEL W/RUBBER PAD 15.4 IN.	ZL1A 15.4 IN. LCD BEZEL ASSY S.P.	60.T50V7.006
<b>TV TUNER</b>			
	TV TUNER M103(HYBRID/SW MPEG)	ZL7 TV TUNER MODULE ASSY M103 S/P	55.A76V7.001
	TV TUNER M104(ANALOG/HW MPEG)	ZL7 TV TUNER MODULE ASSY M104 S/P	55.A76V7.002
	TV TUNER M115(HYBRID/HW MPEG)	ZL7 TV TUNER MODULE ASSY M115 S/P	55.A76V7.003
	REMOTE CONTROLLER - NORMAL -FORWARD 48-KEY	ZL7 REMOTE CONTROLLER 48-KEY S/P	LZ.A2902.001
	REMOTE CONTROLLER - NORMAL -FORWARD 48-KEY	ZL7 REMOTE CONTROLLER 14-KEY S/P	LZ.A6102.001
	REMOTE CONTROLLER - MCE	ZL7 REMOTE CONTROLLER - MCE S/P	LC.MCE05.001
	REMOTE CONTROLLER RECEIVER -MCE	ZL7 REMOTE CONTROLLER RECEIVER -MCE S/P	LC.MCE05.002
	IR BLASTER - MCE	IR BLASTER - MCE S/P	LC.MCE05.003
<b>MAINBOARD</b>			

Illustration	Item	Description	Acer P/N
	MAINBOARD 915GM UMA DOCKING 3 IN 1 W/ PCMCIA SLOT W/O CPU MEMORY	ZL7D M/B (M26-128) ASSY S.P.	LB.A7606.001
	MAINBOARD 915PM 256MB W/PCMCIA SLOT 4 IN 1 READER W/O CPU MEMORY	ZL7D M/B (M26-256) ASSY S.P.	LB.A7706.001
	MAINBOARD 915GM UMA W/PCMCIA SLOT 4 IN 1 READER W/O CPU MEMORY	ZL7D M/B (UMA) ASSY S.P.	LB.A7806.001
	RTC BATTERY ML1220	BATTERY LI 3V 14MAH(ML1220)L-F S.P.	23.T42V7.001
MEMORY			
	MEMORY DDR333 256MB INFINEON HYS64D32020HDL-6-C (.11u)	MEMORY DDR333 256MB INFINEON HYS64D32020HDL-6-C (.11u)	KN.25602.012
	256M Micron SO-DIMM DDR333 256MB MT4VDDT3264HG-335C2	256M Micron SO-DIMM DDR333 256MB MT4VDDT3264HG-335C2	KN.25604.016
	MEMORY DDR333 256MB SAMSUNG M470L3224FT0-CB3	MEMORY DDR333 256MB SAMSUNG M470L3224FT0-CB3	KN.2560B.008
	MEMORY DDR333 256MB MICRON MT8VDDT3264HDG-335C3	MEMORY DDR333 256MB MICRON MT8VDDT3264HDG-335C3	KN.25604.009
	512MB Micron SO-DIMM DDR333 512MB MT8VDDT6464HDG-335C1 (.11u),	512MB Micron SO-DIMM DDR333 512MB MT8VDDT6464HDG-335C1 (.11u),	KN.51204.013
	MEMORY DDR333 512MB SAMSUNG M470L6524BT0-CB3	MEMORY DDR333 512MB SAMSUNG M470L6524BT0-CB3	KN.5120B.006
	SO-DIMM DDR333 512MB UNIFOSA U30512AAUIQ652AW20	SO-DIMM DDR333 512MB UNIFOSA U30512AAUIQ652AW20	KN.5120H.001
	MEMORY DDR333 1GB ELPIDA EBD11UD8ADDA	SO-DIMM DDR333 1GB ELPIDA EBD11UD8ADDA	KN.1GB09.002
SPEAKER			
	SPEAKER SET	ZL1A SPEAKER ASSY S.P.	23.T50V7.001
HEATSINK			

Illustration	Item	Description	Acer P/N
	THERMAL MODULE - FOR M26	ZL7 M26 CPU HEATSINK ASSY	60.T63V7.003
	THERMAL MODULE - FOR UMA	ZL7 UMA CPU HEATSINK ASSY	60.A76V7.002
	VGA HEATSINK FOR DISCRETE W/PAD	ZL2 SINK VGA ASSY W/ NB	60.T63V7.003
<b>MISCELLANEOUS</b>			
	NAME PLATE	ZL7D NAME PLATE S/P	40.A76V7.001
	RUBBER FOOT	ZL1A RUBBER FOOT S.P.	47.T50V7.002
	LCD SCREW RUBBER PAD	ZL1A RUBBER PAD-UP S.P.	47.T50V7.003
	LCD BEZEL RUBBER PAD	ZL1A RUBBER PAD-2 S.P.	47.T50V7.004
<b>SCREW</b>			
	SCREW M2.0X3.0-I-NI-NYLOK	ET2S SCREW MM2.0X3.0 SPARE PART	86.A03V7.012
	SCREW I2.5*3M-BNIH(M2.5L3)	ZG1S I2.5*3M-BNIH(M2.5L3) S/P	86.T25V7.012
	SCREW M2.5*4L-BZN-NYLOK	ET2S SCREW MM2.5X4.0 SPARE PART	86.A03V7.006
	SCREW M2.0X5-I-NI-NYLOK	ZI1S SCREW M2.0X5-I-NI-NYLOK S/P	86.T23V7.006
	SCREW MM25060IL69	DT1 SCREW MM25060IL69 SPARE PART	86.A08V7.004
	SCREW M2.0*5-I(NI)(NYLOK)	ZI1S SCREW M2.5X5.0-I-NI-NYLOK S/P	86.T23V7.010
	SCREW M2.0X2.5-I-NI-NYLOK	ET2S SCREW MM2.0X2.5 SPARE PART	86.A03V7.007
	SCREW I2*3M-NIHY (M2L3)	ZG1S I2*3M-NIHY (M2L3) S/P	86.T25V7.008
	SCREW M1.7*3.0-I (BK)	ZL1A SCREW (M1.7*3.1-I (BK) S.P.	86.T50V7.001
	SCREW I3*3.5M-NIH(M3L3.5)	ET2S SCREW MM3.0X3.5 SPARE PART	86.A03V7.011



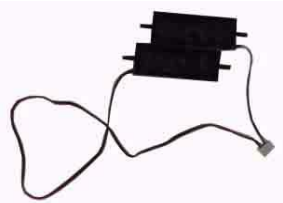