

maintenance & service guide

Presario 1400 Series

Model XL240, XL241, XL242, XL244, XL245, XL246, XL247, XL250, XL340, XL341, XL342, XL343, XL344, XL345, XL346, XL350, XL352, XL355, and XL356

Removal Sequence

This section describes the removal and replacement process for the Presario 1400 Series Notebook. The procedures are divided into two subsections: The Customer Removable Parts and [The Service Removable Parts](#). The first subsection explains which parts may be removed by the customer/owner, and the second subsection explains which parts should be serviced by the technician.

The Customer Removable Parts

Serial Number

Report your Notebook's serial number  to Compaq when requesting information or ordering spare parts. The serial number is located on the underside of the Notebook as shown below.

 **WARNING:** Prior to servicing your Notebook, disconnect AC power cords and external devices, and remove the battery pack and any PC Cards. Failure to disconnect electrical devices may cause damage to the Notebook and loss of human life.

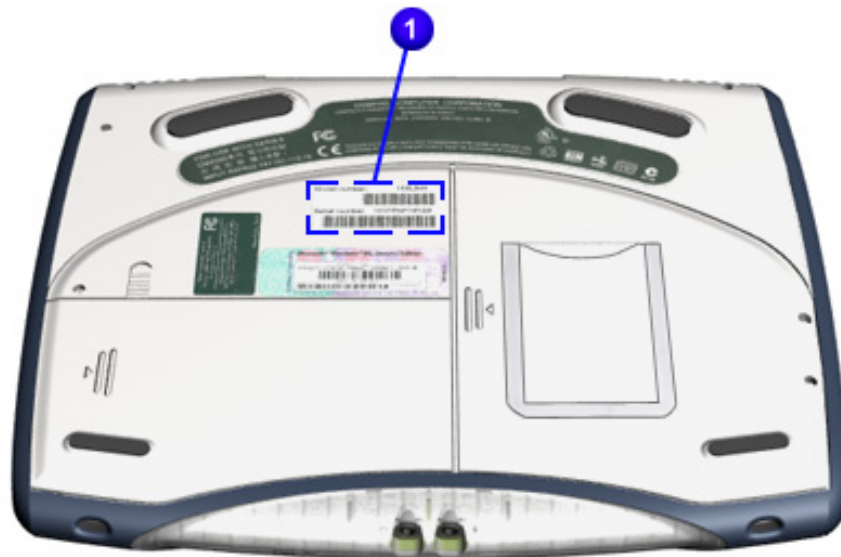

1.800.AT.COMPAQ

maintenance & service guide

Presario 1400 Series

Model XL240, XL241, XL242, XL244, XL245, XL246, XL247, XL250, XL340, XL341, XL342, XL343, XL344, XL345, XL346, XL350, XL352, XL355, and XL356

Electrostatic Discharge

A sudden discharge of static electricity from a finger or other conductor can destroy static-sensitive devices or microcircuitry. Often the spark is neither felt nor heard, but damage occurs. An electronic device that has been exposed to electrostatic discharge (ESD) may not seem to be affected and work perfectly throughout a normal cycle. Although the Notebook may function normally for a period of time, it may have been degraded in the internal layers, reducing the its life expectancy.

Networks built into many integrated circuits provide some protection, but in many cases the discharge contains enough power to alter device parameters or melt silicon junctions.

Generating Static

The table below shows activities that generate static electricity and the associated level of electrostatic voltage.

Typical Electrostatic Voltages			
Event	Relative Humidity		
	10%	40%	55%
Walking across carpet	35,000 V	15,000 V	7,500 V
Walking across vinyl floor	12,000 V	5,000 V	3,000 V
Motions of bench worker	6,000 V	800 V	400 V
Removing DIPS from plastic tubes	2,000 V	700 V	400 V
Removing DIPS from vinyl trays	11,500 V	4,000 V	2,000 V
Removing DIPS from Styrofoam	14,500 V	5,000 V	3,500 V
Removing bubble pack from PCBs	26,000 V	20,000 V	7,000 V
Packing PCBs in foam-lined box	21,000 V	11,000 V	5,000 V
Note: 700 volts can degrade a product.			

maintenance & service guide

Presario 1400 Series

Model XL240, XL241, XL242, XL244, XL245, XL246, XL247, XL250, XL340, XL341, XL342, XL343, XL344, XL345, XL346, XL350, XL352, XL355, and XL356

Service Considerations

During the disassembly and assembly of your Notebook, please keep in mind the considerations listed below.

Tool and Software Requirements

Customer serviceable parts only require the following items during disassembly:

- Small standard screwdriver
- Small Phillips screwdriver
- Diagnostics software

Screws

The screws used on the customer removable parts are Phillips. These screws are not interchangeable. If an incorrect screw is applied during the reassembly process, it can damage the unit. Compaq strongly recommends that you keep all screws with their respective parts as they are removed during disassembly. Then replace the screws in their proper locations.

Important: As each subassembly is removed from the Notebook, place it away from the work area to prevent damage.

Note: Screws inside the Compaq Presario 1400 Series Portable Notebooks vary in size and are **not** interchangeable. During reassembly care must be taken to return the correct screws to their original location. Keep all screws with their respective subassembly during removal.

maintenance & service guide

Presario 1400 Series

Model XL240, XL241, XL242, XL244, XL245, XL246, XL247, XL250, XL340, XL341, XL342, XL343, XL344, XL345, XL346, XL350, XL352, XL355, and XL356

Notebook Disassembly

Before beginning The Removal and Replacement Procedures, complete the following steps:

1. Disconnect AC power and any external devices.
2. Remove any PC cards.
3. Remove the battery pack ([pg 5](#)).

 **WARNING:** Battery pack contains harmful components when exposed. Do not open, crush, puncture, or incinerate the battery pack. It contains no field-serviceable parts. Dispose of battery packs properly. Failure to dispose of battery packs properly may cause harm to humans, animals, and their environment.

 **CAUTION:** Metal objects can damage the battery pack as well as the battery contacts in the battery compartment. To prevent damage, do not allow metal objects to touch the battery contacts. Place only the battery pack for the Compaq Presario 1400 Series Portable Notebooks into the battery compartment. Do not force the battery pack into the bay if insertion does not occur easily. Do not open a battery pack; opening causes damage to the pack, making it unuseable and exposing harmful battery components.

maintenance & service guide

Presario 1400 Series

Model XL240, XL241, XL242, XL244, XL245, XL246, XL247, XL250, XL340, XL341, XL342, XL343, XL344, XL345, XL346, XL350, XL352, XL355, and XL356

Battery Pack

To remove the battery pack, complete the following steps:

1. Slide the battery compartment door switch ❶ up to release the door.
2. Simultaneously slide door ❷ right.
3. Lift door to remove.

Important: The battery pack should be removed before performing any internal maintenance on the Notebook.

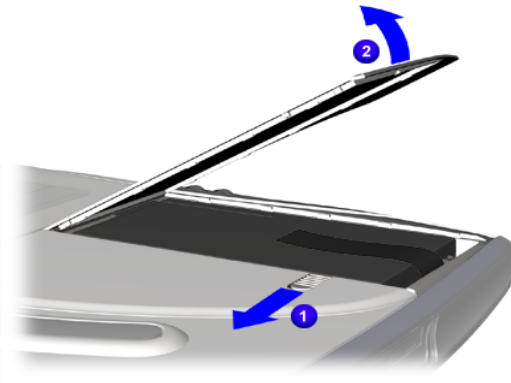

WARNING: Battery pack contains harmful components when exposed. Do not open, crush, puncture, or incinerate the battery pack. It contains no field-serviceable parts. Dispose of battery packs properly. Failure to dispose of battery packs properly may cause harm to humans, animals, and their environment.

CAUTION: Metal objects can damage the battery pack as well as the battery contacts in the battery compartment. To prevent damage, do not allow metal objects to touch the battery contacts. Place only the battery pack for the Compaq Presario 1400 Series Portable Notebooks into the battery compartment. Do not force the battery pack into the bay if insertion does not occur easily. Do not open a battery pack; opening causes damage to the pack, making it unuseable and exposing harmful battery components.

[Continued](#)

maintenance & service guide

Presario 1400 Series

Model XL240, XL241, XL242, XL244, XL245, XL246, XL247, XL250, XL340, XL341, XL342, XL343, XL344, XL345, XL346, XL350, XL352, XL355, and XL356

4. Pull up on battery pack ribbon.
5. Disconnect battery pack from connectors.
6. Lift battery pack from compartment.

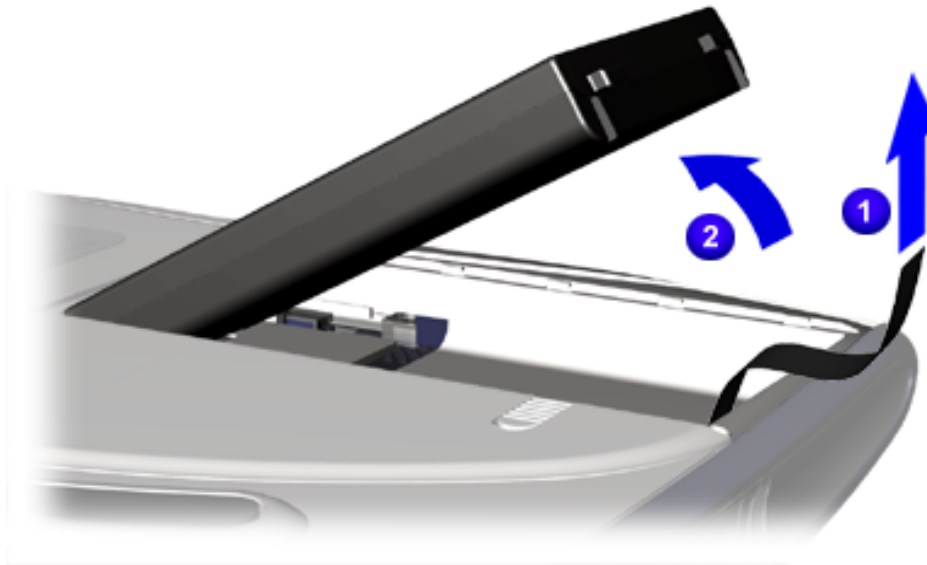

To replace the battery pack, reverse these procedures.

WARNING: Battery pack contains harmful components when exposed. Do not open, crush, puncture, or incinerate the battery pack. It contains no field-serviceable parts. Dispose of battery packs properly. Failure to dispose of battery packs properly may cause harm to humans, animals, and their environment.

CAUTION: Metal objects can damage the battery pack as well as the battery contacts in the battery compartment. To prevent damage, do not allow metal objects to touch the battery contacts. Place only the battery pack for the Compaq Presario 1400 Series Portable Notebooks into the battery compartment. Do not force the battery pack into the bay if insertion does not occur easily. Do not open a battery pack; opening causes damage to the pack, making it unuseable and exposing harmful battery components.

maintenance & service guide

Presario 1400 Series

Model XL240, XL241, XL242, XL244, XL245, XL246, XL247, XL250, XL340, XL341, XL342, XL343, XL344, XL345, XL346, XL350, XL352, XL355, and XL356

Cosmetic Side Covers

To remove the Cosmetic Side Covers, complete the following steps:

1. Prepare the Notebook for disassembly ([pg 4](#)).
2. Remove one screw located on the side near the back of the unit with a Phillips screwdriver from the cosmetic side cover, left or right.
3. Slide or shift the cosmetic side cover backward to remove it from the Notebook.
4. Repeat this procedure for the other cosmetic side cover.

Note: To determine left and right sides of the Notebook, as referenced in this guide, face the front of the unit toward you. As referenced in this guide, your left will be the same as the Notebook's left side, and your right will be the same as the Notebook's right side.



To replace the Cosmetic Side Covers, reverse the procedure.

maintenance & service guide

Presario 1400 Series

Model XL240, XL241, XL242, XL244, XL245, XL246, XL247, XL250, XL340, XL341, XL342, XL343, XL344, XL345, XL346, XL350, XL352, XL355, and XL356

Speaker Port Covers

To remove the Speaker Port Covers, complete the following steps:

1. Prepare the Notebook for disassembly ([pg 4](#)).
2. Remove the cosmetic side covers ([pg 7](#)).
3. Remove the upper and lower Speaker Port Covers from chassis.



To replace the Speaker Port Covers, reverse these procedures.

Presario 1400 Series

Model XL240, XL241, XL242, XL244, XL245, XL246, XL247, XL250, XL340, XL341, XL342, XL343, XL344, XL345, XL346, XL350, XL352, XL355, and XL356

Modem/Memory Access Door

To remove the Modem/Memory Access Door, complete the following steps:

1. Prepare the Notebook for disassembly ([pg 4](#)).
2. Turn the Notebook upside down.
3. Remove the one screw **1** with Phillips screwdriver from the Modem/Memory Access Door **2**.
4. Lift up and remove the Modem/Memory Access Door from the unit.

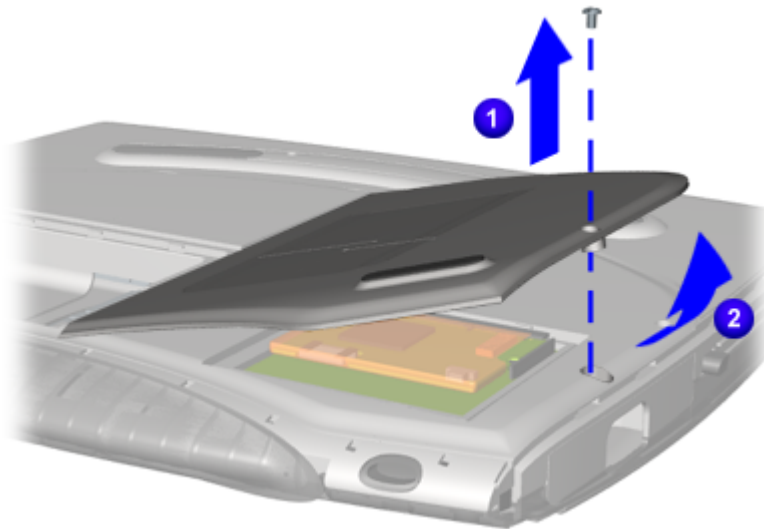

Note: The illustration may show extra components removed that are not necessary for this step. Complete only the written steps that are provided.

To replace the Modem/Memory Access Door, reverse these procedures.

maintenance & service guide

Presario 1400 Series

Model XL240, XL241, XL242, XL244, XL245, XL246, XL247, XL250, XL340, XL341, XL342, XL343, XL344, XL345, XL346, XL350, XL352, XL355, and XL356

Modem or Network/Modem Combo Card

To remove the Modem, complete the following steps:

1. Prepare the Notebook for disassembly ([pg 4](#)).
2. Turn the Notebook over.
3. Remove the Modem/Memory Access door from the unit ([pg 9](#)).
4. Pull the tab **1** on each side of the Modem or Network/Modem Card.
5. Lift and remove the card **2** from the chassis.

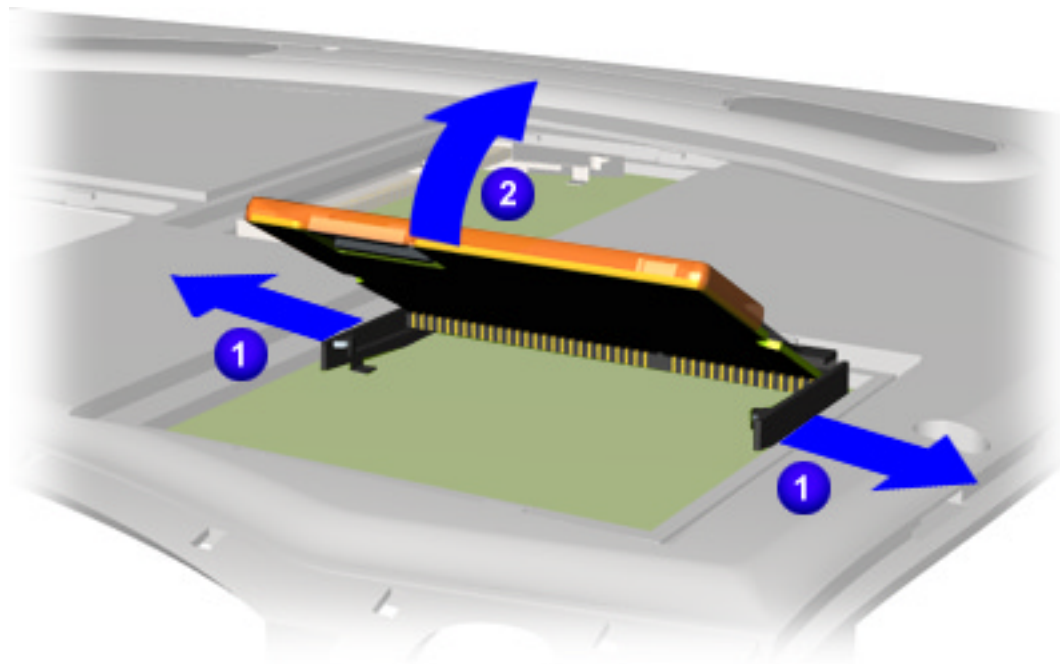

To replace the Modem, reverse these procedures.

maintenance & service guide

Presario 1400 Series

Model XL240, XL241, XL242, XL244, XL245, XL246, XL247, XL250, XL340, XL341, XL342, XL343, XL344, XL345, XL346, XL350, XL352, XL355, and XL356

Extended Memory Card

To remove the Extended Memory Card, complete the following steps:

1. Prepare the Notebook for disassembly ([pg 4](#)).
2. Turn the Notebook upside down.
3. Remove the Modem/Memory Access door ([pg 9](#)).
4. Pull the tab **1** on each side of the Extended Memory Card.
5. Lift and remove the Extended Memory Card **2** from the connectors.

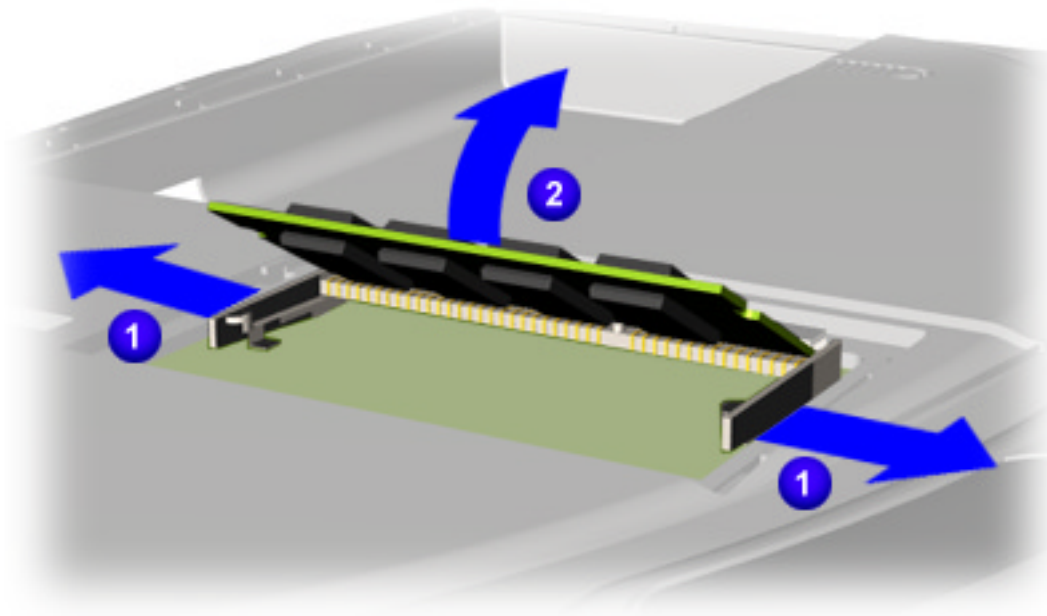

To replace the Extended Memory Card, reverse these procedures.

maintenance & service guide

Presario 1400 Series

Model XL240, XL241, XL242, XL244, XL245, XL246, XL247, XL250, XL340, XL341, XL342, XL343, XL344, XL345, XL346, XL350, XL352, XL355, and XL356

DVD, CD-Rom, or CD-RW Drive

To remove the DVD, CD-Rom, or CD-RW Drive, complete the following steps:

1. Prepare the Notebook for disassembly ([pg 4](#)).
2. Remove the right cosmetic side cover ([pg 7](#)).

Note: It is not necessary to remove the left cosmetic side cover to remove the DVD, CD-Rom, or CD-RW Drive.

3. Turn the Notebook upside down.
4. Remove two screws from underneath the unit on the left side.

Note: The illustration may show extra components removed that are not necessary for this step. Complete only the written steps that are provided.

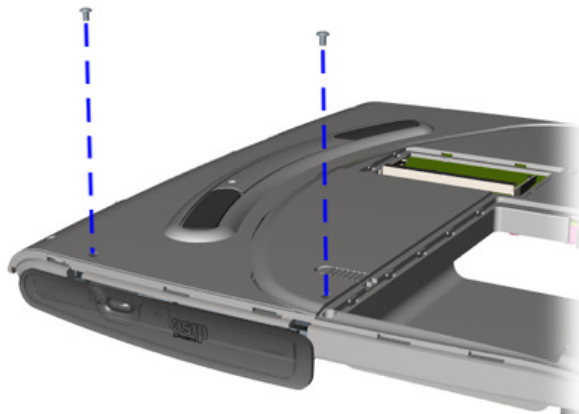

[Continued](#)

maintenance & service guide

Presario 1400 Series

Model XL240, XL241, XL242, XL244, XL245, XL246, XL247, XL250, XL340, XL341, XL342, XL343, XL344, XL345, XL346, XL350, XL352, XL355, and XL356

5. Turn the Notebook over.
6. Slide the DVD, CD-Rom, or CD-RW Drive out to remove.

Note: The illustration may show extra components removed that are not necessary for this step. Complete only the written steps that are provided.

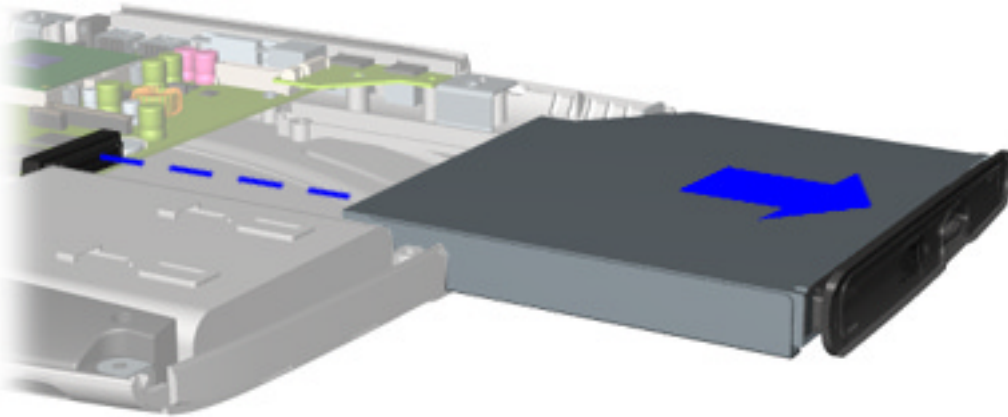

To replace the DVD, CD-Rom, or CD-RW Drive, reverse these procedures.

maintenance & service guide

Presario 1400 Series

Model XL240, XL241, XL242, XL244, XL245, XL246, XL247, XL250, XL340, XL341, XL342, XL343, XL344, XL345, XL346, XL350, XL352, XL355, and XL356

Hard Drive

To remove the Hard Drive, complete the following steps:

1. Prepare the Notebook for disassembly ([pg 4](#)).
2. Remove the left cosmetic side cover ([pg 7](#)).

Note: It is not necessary to remove the right cosmetic side cover to remove the Hard Drive.

3. Turn the Notebook upside down.
4. Remove one screw from underneath the unit.

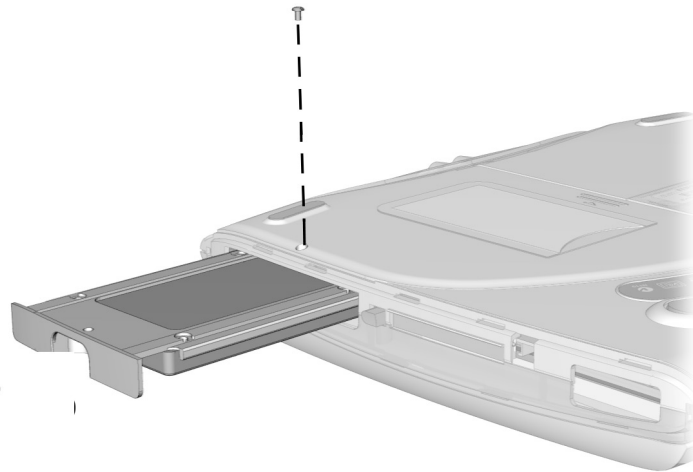

[Continued](#)

maintenance & service guide

Presario 1400 Series

Model XL240, XL241, XL242, XL244, XL245, XL246, XL247, XL250, XL340, XL341, XL342, XL343, XL344, XL345, XL346, XL350, XL352, XL355, and XL356

5. Turn the unit over.
6. Slide the Hard Drive out and remove.

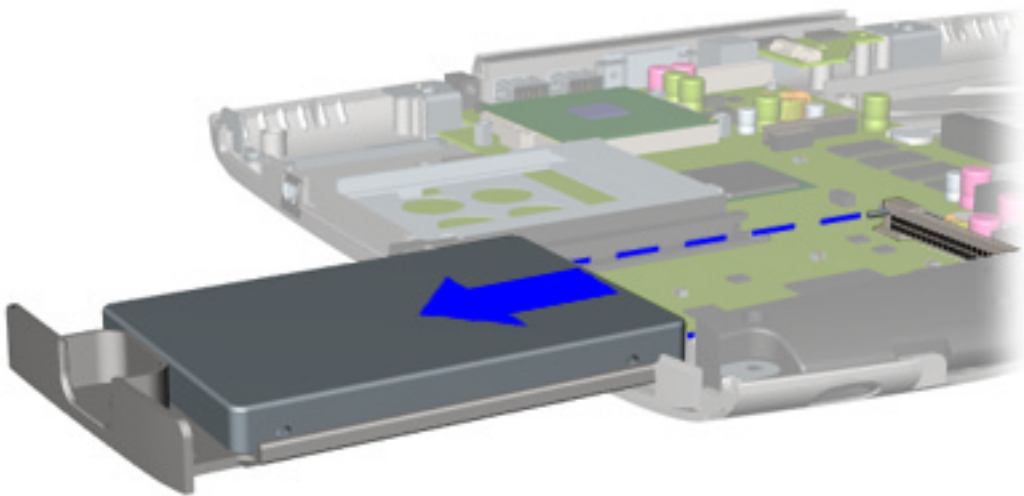

To replace the Hard Drive, reverse the procedure.

maintenance & service guide

Presario 1400 Series

Model XL240, XL241, XL242, XL244, XL245, XL246, XL247, XL250, XL340, XL341, XL342, XL343, XL344, XL345, XL346, XL350, XL352, XL355, and XL356

The Service Removable Parts

Serial Number

When customers request information or order spare parts, be sure to ask them for their Notebook's serial number ❶. It is located on the underside of the unit.

Before servicing the unit, refer to Preparing the Notebook for Disassembly ([pg 4](#)).

⚠ WARNING: Before servicing the Notebook, disconnect AC power cords and external devices, and remove the battery pack and any PC Cards. Failure to disconnect electrical devices may cause damage to the Notebook and loss of human life.

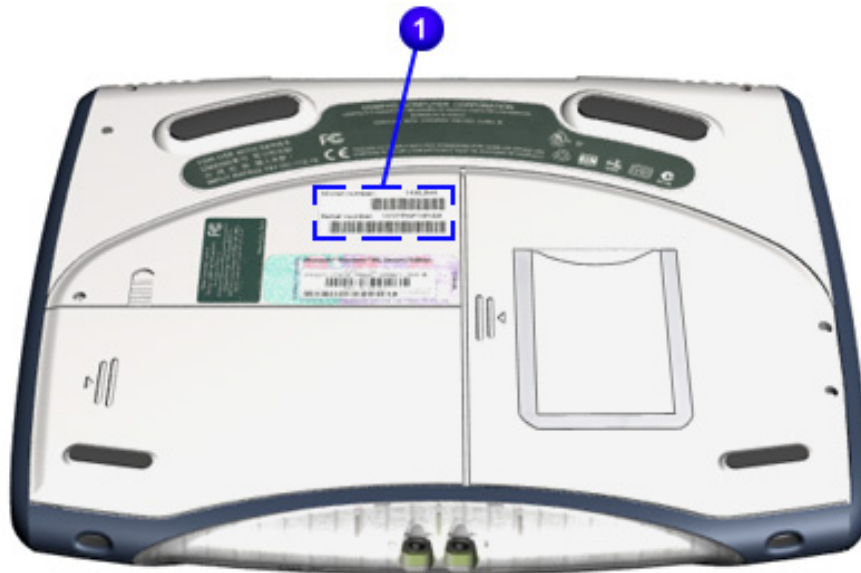

maintenance & service guide

Presario 1400 Series

Model XL240, XL241, XL242, XL244, XL245, XL246, XL247, XL250, XL340, XL341, XL342, XL343, XL344, XL345, XL346, XL350, XL352, XL355, and XL356

Electrostatic Discharge

A sudden discharge of static electricity from a finger or other conductor can destroy static-sensitive devices or microcircuitry. Often the spark is neither felt nor heard, but damage occurs. An electronic device that has been exposed to electrostatic discharge (ESD) may not seem to be affected and work perfectly throughout a normal cycle. Although it may function normally for a period of time, it may have been degraded in the internal layers, reducing its life expectancy.

Networks built into many integrated circuits provide some protection, but in many cases the discharge contains enough power to alter device parameters or melt silicon junctions.

Generating Static

The table below shows activities that generate static electricity and their associated level of electrostatic voltage.

Typical Electrostatic Voltages			
Event	Relative Humidity		
	10%	40%	55%
Walking across carpet	35,000 V	15,000 V	7,500 V
Walking across vinyl floor	12,000 V	5,000 V	3,000 V
Motions of bench worker	6,000 V	800 V	400 V
Removing DIPS from plastic tubes	2,000 V	700 V	400 V
Removing DIPS from vinyl trays	11,500 V	4,000 V	2,000 V
Removing DIPS from Styrofoam	14,500 V	5,000 V	3,500 V
Removing bubble pack from PCBs	26,000 V	20,000 V	7,000 V
Packing PCBs in foam-lined box	21,000 V	11,000 V	5,000 V
Note: 700 volts can degrade a product.			

maintenance & service guide

Presario 1400 Series

Model XL240, XL241, XL242, XL244, XL245, XL246, XL247, XL250, XL340, XL341, XL342, XL343, XL344, XL345, XL346, XL350, XL352, XL355, and XL356

Service Considerations

During the disassembly and assembly of the Notebook, please keep in mind the considerations listed below.

Tool and Software Requirements

To service the Notebook, the following items are required:

- Torx T-8 or T-9 screwdriver
- 5mm nut drivers (for screwlocks and standoffs)
- Small standard screwdriver
- Small Phillips screwdriver
- Diagnostics software

Screws

The screws are not interchangeable. If an incorrect screw is applied during the reassembly process, it can damage the unit. Compaq strongly recommends that you keep all screws with their respective parts as they are removed during disassembly. Then replace the screws in their proper locations.

As each subassembly is removed from the Notebook, place it away from the work area to prevent damage.

maintenance & service guide

Presario 1400 Series

Model XL240, XL241, XL242, XL244, XL245, XL246, XL247, XL250, XL340, XL341, XL342, XL343, XL344, XL345, XL346, XL350, XL352, XL355, and XL356

Cables and Connectors

Most of the cables inside the Notebook are ribbon cables. Handle cables with extreme care to avoid damage. During insertion or removal from the connector, apply only the amount of pressure required to seat or unseat the cable, handling it by the connector whenever possible. In all cases, avoid bending, twisting, or tearing the cables. Route cables in such a way that they cannot be caught or snagged by parts being removed or replaced.

Cables

To avoid damage to the cable or the Notebook, the following precautions should be taken when handling cables:

- Always handle cables by their connectors.
- Avoid bending, twisting, or pulling on the cables.
- Apply minimum required force when seating or unseating the cables from their connectors.
- Place the cables in such a manner that they cannot be caught or snagged by parts being removed or replaced.
- Handle flex cables with extreme care; they can tear easily.

 **CAUTION:** When servicing Notebooks, place cables in their proper location during the reassembly process. Improper cable placement can cause severe damage to the Notebook.

Cable Illustrations

The following illustrations show the proper placement for each cable:

- [Zif Cable](#)
- [Speaker Assembly Cable](#)
- [Keyboard Ribbon Cable](#)
- [NIC Cable](#)

maintenance & service guide

Presario 1400 Series

Model XL240, XL241, XL242, XL244, XL245, XL246, XL247, XL250, XL340, XL341, XL342, XL343, XL344, XL345, XL346, XL350, XL352, XL355, and XL356

Connectors and Plastic Parts

Plastic parts can be damaged by the use of excessive force during disassembly and reassembly. Handle with care when disassembling and assembling plastic parts. As recommended in the maintenance instructions, apply pressure only at the designated points.

ZIF Connectors

The Notebook uses zero insertion force (ZIF) connectors on the system board.

 **CAUTION:** A ZIF connector and its attached cable can be easily damaged. Handle only the connector slide when removing or replacing a cable. Never pull or twist on a cable while it is connected.

To remove a cable from a ZIF connector, lift both corners of the ZIF connector and slide simultaneously with constant light pressure.

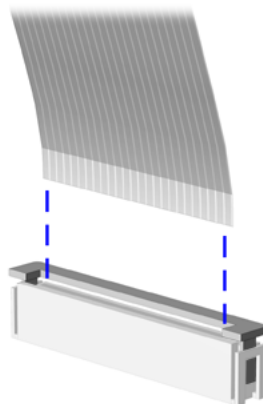

 **CAUTION:** When servicing a Notebook, place cables in their proper location during the reassembly process. Improper cable placement can cause severe damage to the Notebook.

To view other cables, click [Cable Illustrations](#).

maintenance & service guide

Presario 1400 Series

Model XL240, XL241, XL242, XL244, XL245, XL246, XL247, XL250, XL340, XL341, XL342, XL343, XL344, XL345, XL346, XL350, XL352, XL355, and XL356

Speaker Assembly Cable

The ribbon cable position for the speaker assembly is shown below.

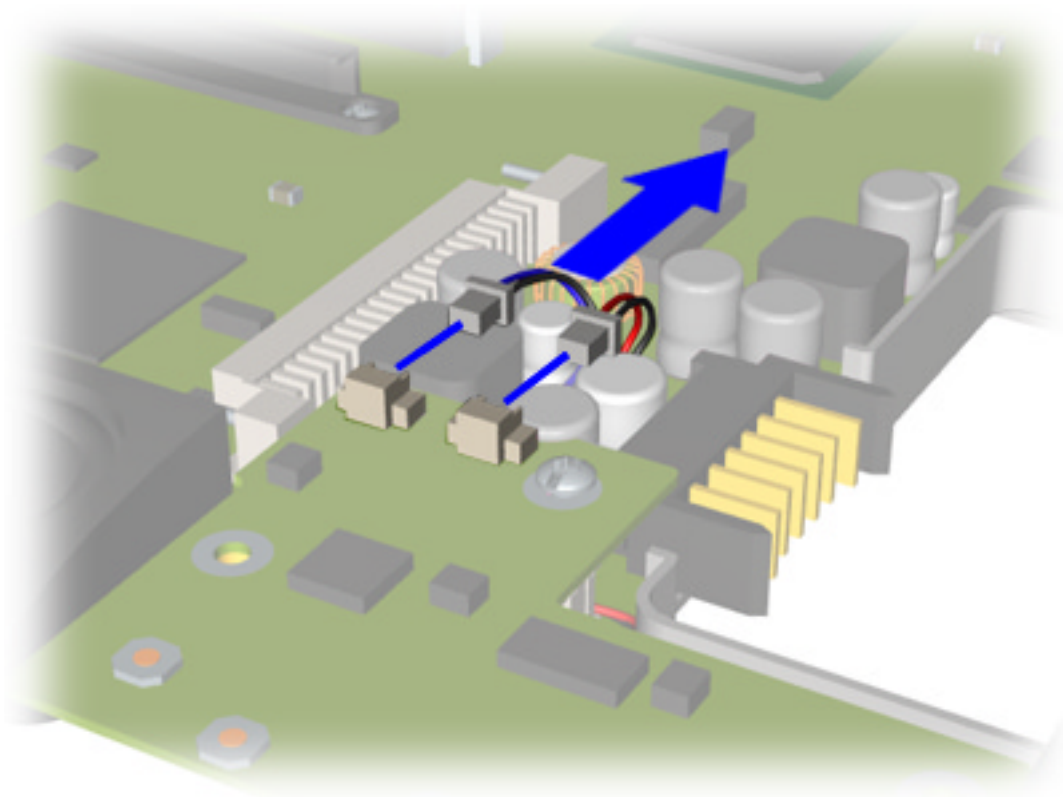

CAUTION: When servicing a Notebook, place cables in their proper location during the reassembly process. Improper cable placement can cause severe damage to the Notebook.

To view other cables, click [Cable Illustrations](#).

maintenance & service guide

Presario 1400 Series

Model XL240, XL241, XL242, XL244, XL245, XL246, XL247, XL250, XL340, XL341, XL342, XL343, XL344, XL345, XL346, XL350, XL352, XL355, and XL356

Keyboard Ribbon Cable

The ribbon cable position for the keyboard is shown below.

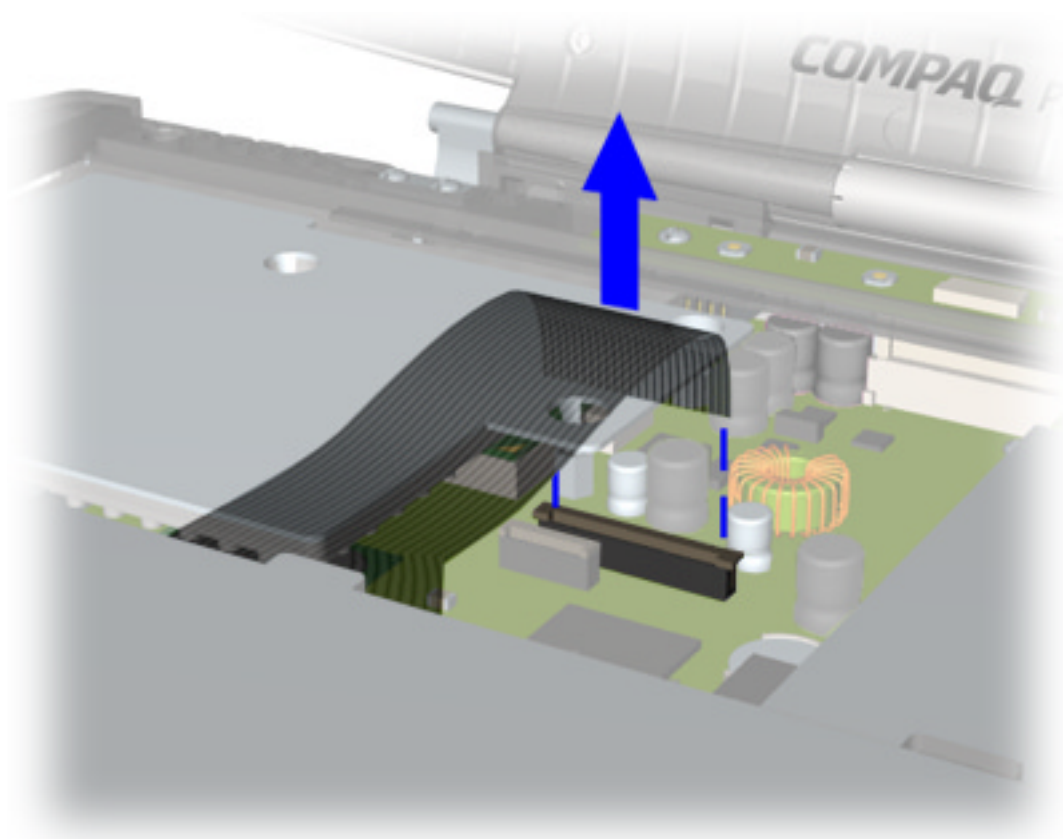

CAUTION: When servicing a Notebook, place cables in their proper location during the reassembly process. Improper cable placement can cause severe damage to the Notebook.

To view other cables, click [Cable Illustrations](#).

maintenance & service guide

Presario 1400 Series

Model XL240, XL241, XL242, XL244, XL245, XL246, XL247, XL250, XL340, XL341, XL342, XL343, XL344, XL345, XL346, XL350, XL352, XL355, and XL356

Internet Button Board Cover

1. Prepare the Notebook for disassembly ([pg 4](#)).
2. Remove the cosmetic side covers ([pg 7](#)).
3. Turn the Notebook upside down.
4. Remove the two screws from underneath the unit toward the rear.

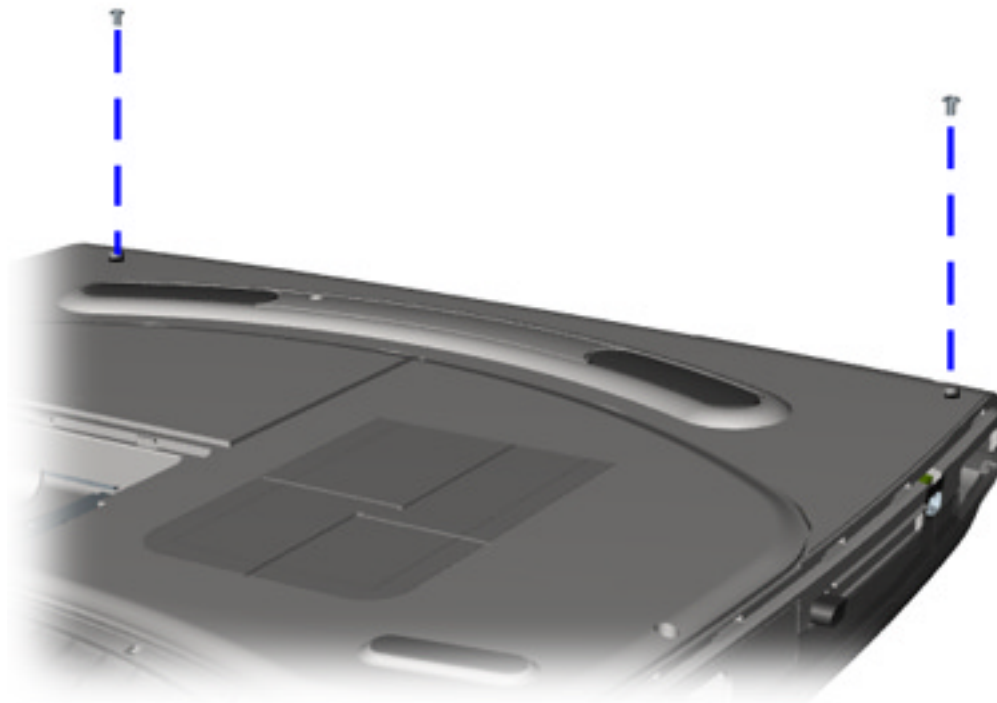

[Continued](#)

maintenance & service guide

Presario 1400 Series

Model XL240, XL241, XL242, XL244, XL245, XL246, XL247, XL250, XL340, XL341, XL342, XL343, XL344, XL345, XL346, XL350, XL352, XL355, and XL356

5. Carefully pry with the flat end of a screwdriver to lift the Internet Button Board Cover.
6. Disconnect the backlight and flex cables.
7. Remove the Internet Button Board Cover from the Notebook.

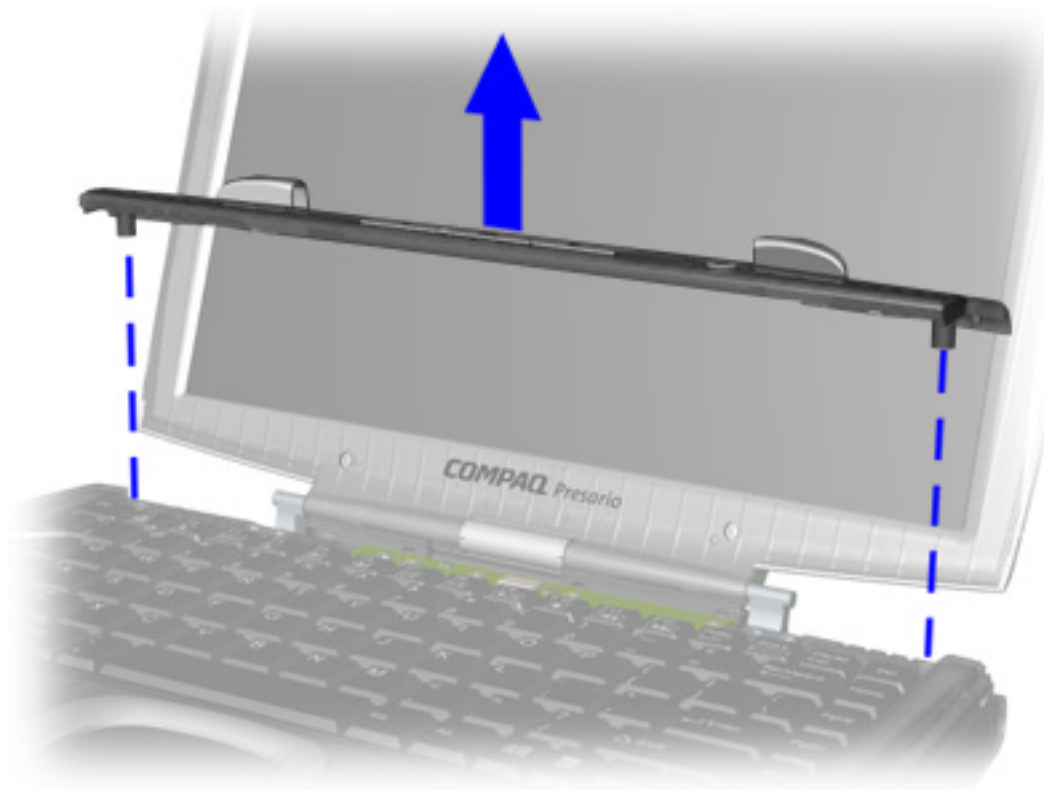

Note: The hinge covers and backlight switch are located on the Internet Button Board Cover.

To replace the Internet Button Board Cover, reverse the procedure.

maintenance & service guide

Presario 1400 Series

Model XL240, XL241, XL242, XL244, XL245, XL246, XL247, XL250, XL340, XL341, XL342, XL343, XL344, XL345, XL346, XL350, XL352, XL355, and XL356

Keyboard

To remove the keyboard, complete the following steps:

1. Prepare the Notebook for disassembly ([pg 4](#)).
2. Remove the cosmetic side covers ([pg 7](#)).
3. Remove the Internet Button Board Cover ([pg 23](#)).
4. Lift the back of the keyboard and disconnect the flex cable from the ZIF Connector on the system board.
5. Remove the keyboard from the unit.



Note: When replacing the keyboard, the Keyboard Ribbon Cable should fold behind the ZIF Connectors rather than underneath the keyboard.

maintenance & service guide

Presario 1400 Series

Model XL240, XL241, XL242, XL244, XL245, XL246, XL247, XL250, XL340, XL341, XL342, XL343, XL344, XL345, XL346, XL350, XL352, XL355, and XL356

PCA Button Board

To remove the PCA Button Board, complete the following steps:

1. Prepare the Notebook for disassembly ([pg 4](#)).
2. Remove the cosmetic side covers ([pg 7](#)).
3. Remove the Internet Button Board Cover ([pg 23](#)).
4. Remove the keyboard ([pg 25](#)).
5. Disconnect the backlight cable from the system board.



Note: Do not use excessive force when removing cables or boards.

[Continued](#)

maintenance & service guide

Presario 1400 Series

Model XL240, XL241, XL242, XL244, XL245, XL246, XL247, XL250, XL340, XL341, XL342, XL343, XL344, XL345, XL346, XL350, XL352, XL355, and XL356

6. Remove two screws ❶ on the PCA Button Board.
7. Pry with the flat end of a screwdriver and lift the PCA Button Board. The data cable that is attached to the PCA Button Board is still connected to the system board.
8. Disconnect the data cable ❸ on the bottom side of the PCA Button Board.
9. Remove the PCA Button Board ❷ from the chassis.

Note: The EMI Shields are lightweight pieces of metal. Be sure not to lose these shields when removing the PCA Button Board or Display Panel Assembly.

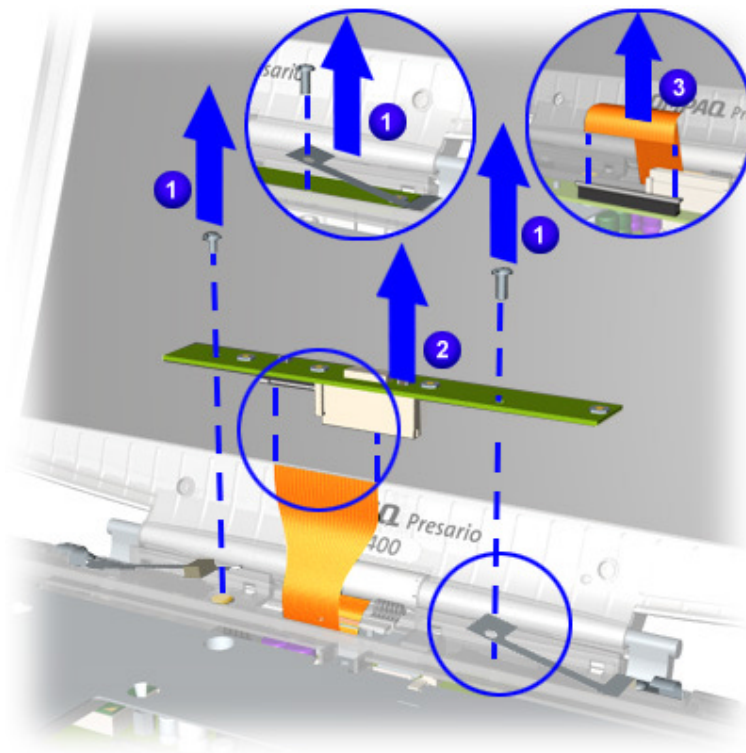

To replace the PCA Button Board, reverse these procedures.

maintenance & service guide

Presario 1400 Series

Model XL240, XL241, XL242, XL244, XL245, XL246, XL247, XL250, XL340, XL341, XL342, XL343, XL344, XL345, XL346, XL350, XL352, XL355, and XL356

Display Panel Assembly

To remove the display panel assembly, complete the following steps:

1. Prepare the Notebook for disassembly ([pg 4](#)).
2. Remove the cosmetic side covers ([pg 7](#)).
3. Remove the Internet Button Board cover ([pg 23](#)).
4. Remove the keyboard ([pg 25](#)).
5. Remove the PCA Button Board ([pg 26](#)).
6. Remove the four screws ❶ from the hinges securing the Display Panel Assembly. Be sure to keep the EMI shields with the Display Panel Assembly.
7. Lift and remove the Display Panel ❷ Assembly from the chassis.

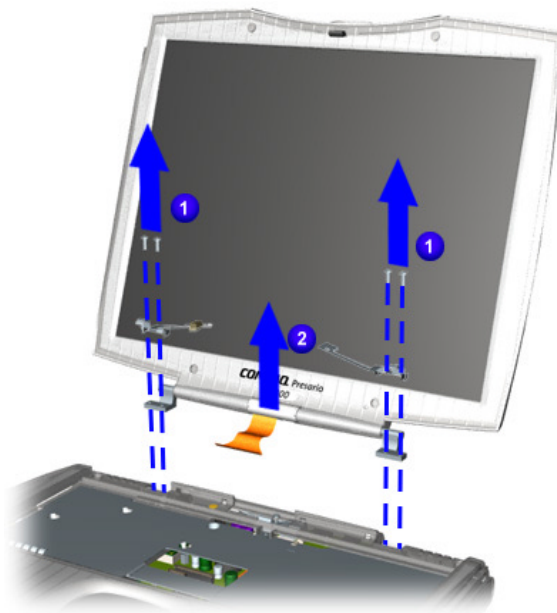

Note: The EMI Shields are lightweight pieces of metal. Be sure not to lose the shields when removing the PCA Button Board or Display Panel Assembly.

To replace the Display Panel Assembly, reverse these procedures.

maintenance & service guide

Presario 1400 Series

Model XL240, XL241, XL242, XL244, XL245, XL246, XL247, XL250, XL340, XL341, XL342, XL343, XL344, XL345, XL346, XL350, XL352, XL355, and XL356

MP3 Zone Cover

To Remove the MP3 Zone Cover, complete the following steps:

1. Prepare the Notebook for disassembly ([pg 4](#)).
2. Remove the cosmetic side covers ([pg 7](#)).
3. Remove the speaker port covers ([pg 8](#)).
4. Remove the four screws **1** from the MP3 Zone Cover.
5. Pull the MP3 Zone Cover **2** forward and remove it from the chassis.

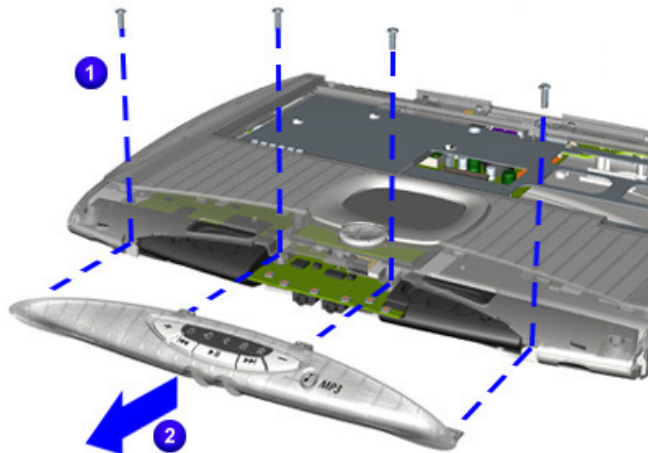

To replace the MP3 Zone Cover, reverse these procedures.

Presario 1400 Series

Model XL240, XL241, XL242, XL244, XL245, XL246, XL247, XL250, XL340, XL341, XL342, XL343, XL344, XL345, XL346, XL350, XL352, XL355, and XL356

Heatspreader with Fan Assembly

To remove the Heatspreader with Fan Assembly, complete the following steps:

1. Prepare the Notebook for disassembly ([pg 4](#)).
2. Remove the cosmetic side covers ([pg 7](#)).
3. Remove the Internet Button Board cover ([pg 23](#)).
4. Remove the keyboard ([pg 25](#)).
5. Remove five screws ❶ with a T-9 Torx driver.
6. Remove the heatspreader ❷ with fan assembly.
7. Disconnect the fan cable ❸ from the system board.

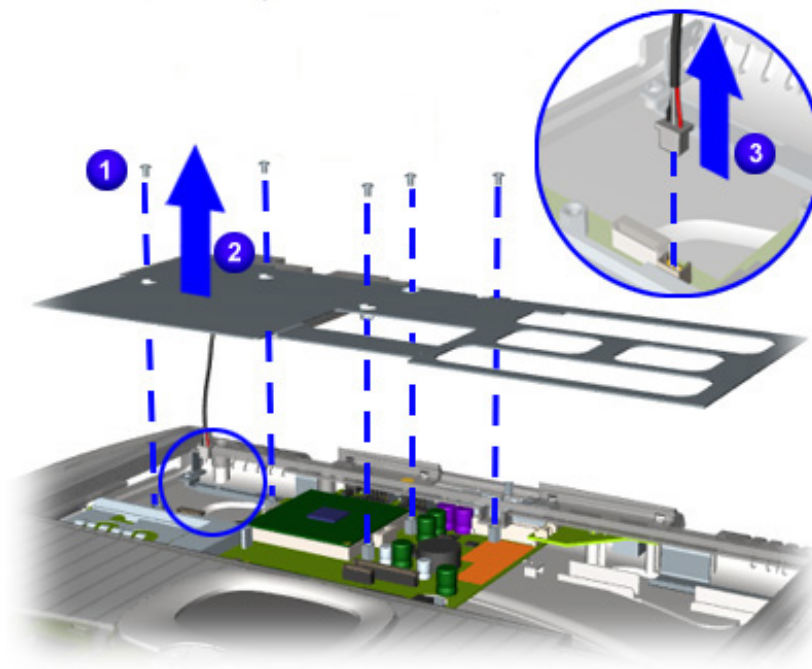

To replace the heatspreader, reverse these procedures.

Note: When replacing the Heatspreader, be sure that the Heatspreader is lying on top of the CPU Upper Cover with Palmrest and Touch Pad. The CD/DVD will not operate if the Heatspreader is installed incorrectly.

maintenance & service guide

Presario 1400 Series

Model XL240, XL241, XL242, XL244, XL245, XL246, XL247, XL250, XL340, XL341, XL342, XL343, XL344, XL345, XL346, XL350, XL352, XL355, and XL356

Fan Assembly

To remove the Fan Assembly, complete the following steps:

1. Prepare the Notebook for disassembly ([pg 4](#)).
2. Remove the cosmetic side covers ([pg 7](#)).
3. Remove the Internet Button Board cover ([pg 23](#)).
4. Remove the keyboard ([pg 25](#)).
5. Remove the Heatspreader with Fan Assembly ([pg 30](#)).
6. Remove two screws **1** with a Phillips screwdriver.
7. Lift and remove the Fan Assembly **2** from the Heatspreader.

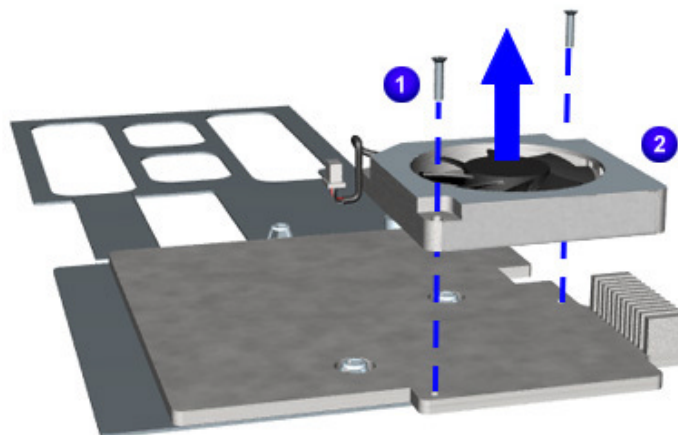

To replace the Fan Assembly, reverse the procedure.

maintenance & service guide

Presario 1400 Series

Model XL240, XL241, XL242, XL244, XL245, XL246, XL247, XL250, XL340, XL341, XL342, XL343, XL344, XL345, XL346, XL350, XL352, XL355, and XL356

Palmrest Cover with TouchPad (Upper CPU)

To remove the Palmrest Cover with TouchPad (Upper CPU), complete the following steps:

1. Prepare the Notebook for disassembly ([pg 4](#)).
2. Remove the cosmetic side covers ([pg 7](#)).
3. Remove the speaker port covers ([pg 8](#)).
4. Remove the Power-on and Internet Button Board Cover ([pg 23](#)).
5. Remove the keyboard ([pg 25](#)).
6. Remove the PCA Button Board ([pg 26](#)).
7. Remove the display panel assembly ([pg 28](#)).
8. Remove the Modem/Memory Access Door ([pg 9](#)).
9. Remove the MP3 Zone Cover ([pg 29](#)).
10. Remove the Heatspreader ([pg 30](#)).

[Continued](#)

maintenance & service guide

Presario 1400 Series

Model XL240, XL241, XL242, XL244, XL245, XL246, XL247, XL250, XL340, XL341, XL342, XL343, XL344, XL345, XL346, XL350, XL352, XL355, and XL356

11. Remove seven screws ① and one standoff from the Upper CPU Cover with Palmrest and TouchPad.
12. Remove the TouchPad data cable with a flat-blade screwdriver.
13. Lift the Upper CPU Cover with Palmrest and TouchPad ② upward and remove it from the chassis.

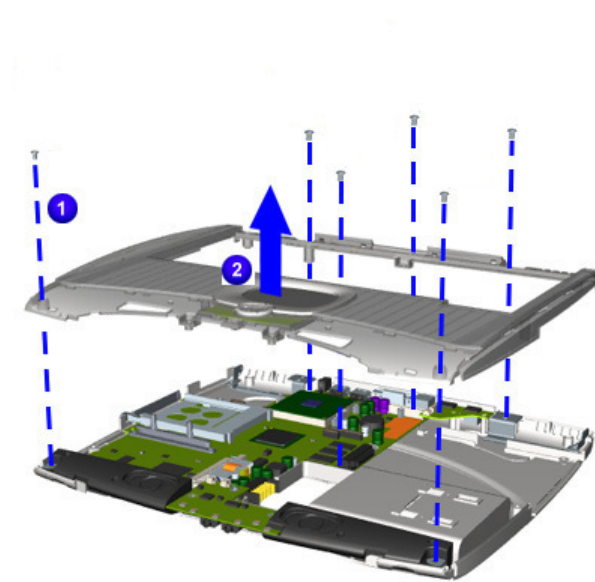

Note: Illustrations may show a fewer number of screws removed. It is necessary to remove only the parts listed in the written procedure.

To replace the Upper CPU Cover with Palmrest and TouchPad, reverse these procedures.

maintenance & service guide

Presario 1400 Series

Model XL240, XL241, XL242, XL244, XL245, XL246, XL247, XL250, XL340, XL341, XL342, XL343, XL344, XL345, XL346, XL350, XL352, XL355, and XL356

Modem/Modem-NIC Combo Cable

To remove the NIC (Network Interface Card) cable, complete the following steps:

1. Prepare the Notebook for disassembly ([pg 4](#)).
2. Remove the cosmetic side covers ([pg 7](#)).
3. Remove the speaker port covers ([pg 8](#)).
4. Remove the Modem/Memory Access Door ([pg 9](#)).
5. Remove the Internet Button Board cover ([pg 23](#)).
6. Remove the keyboard ([pg 25](#)).
7. Remove the PCA Button Board ([pg 26](#)).
8. Remove the display panel assembly ([pg 28](#)).
9. Remove the MP3 zone cover ([pg 29](#)).
10. Remove the heatspreader ([pg 30](#)).
11. Remove the Palmrest Cover with TouchPad, Upper CPU, ([pg 32](#)).

[Continued](#)

maintenance & service guide

Presario 1400 Series

Model XL240, XL241, XL242, XL244, XL245, XL246, XL247, XL250, XL340, XL341, XL342, XL343, XL344, XL345, XL346, XL350, XL352, XL355, and XL356

12. Disconnect and lift off the large end ❶ of the Modem/NIC cable connector located near the hard drive.
13. Disconnect and lift off the small end ❷ of the Modem/NIC cable connector located near the rear of the unit.
14. Remove one standoff with a 5mm nut driver.
15. Remove NIC cable from chassis.

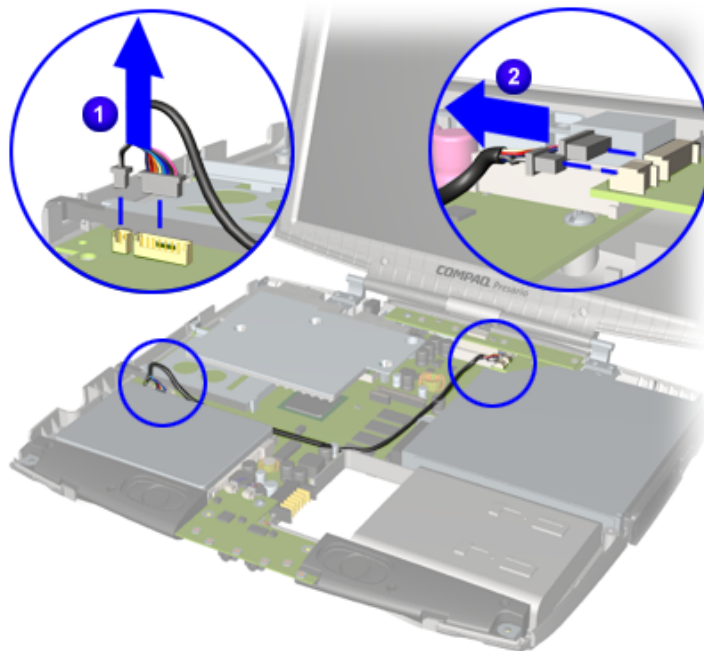

To replace the NIC Cable, reverse the procedure.

maintenance & service guide

Presario 1400 Series

Model XL240, XL241, XL242, XL244, XL245, XL246, XL247, XL250, XL340, XL341, XL342, XL343, XL344, XL345, XL346, XL350, XL352, XL355, and XL356

MP3 Audio Board

To remove the MP3 Audio Board, complete the following steps:

1. Prepare the Notebook for disassembly ([pg 4](#)).
2. Remove the cosmetic side covers ([pg 7](#)).
3. Remove the speaker port covers ([pg 8](#)).
4. Remove the Modem/Memory Access Door ([pg 9](#)).
5. Remove the Internet Button Board Cover ([pg 23](#)).
6. Remove the keyboard ([pg 25](#)).
7. Remove the PCA Button Board ([pg 26](#)).
8. Remove the display panel assembly ([pg 28](#)).
9. Remove the MP3 Zone Cover ([pg 29](#)).
10. Remove the Heatspreader ([pg 30](#)).
11. Remove the Palmrest Cover with TouchPad, Upper CPU, ([pg 32](#)).

[Continued](#)

maintenance & service guide

Presario 1400 Series

Model XL240, XL241, XL242, XL244, XL245, XL246, XL247, XL250, XL340, XL341, XL342, XL343, XL344, XL345, XL346, XL350, XL352, XL355, and XL356

12. Remove one screw ❶ from the system board.
13. Lift and remove the MP3 Audio Board ❷ from the system board.
14. Disconnect the speaker cable from the system board.

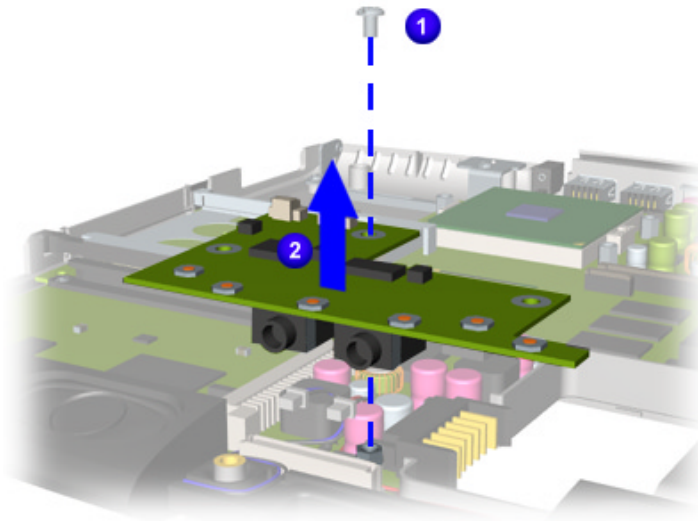

To replace the MP3 Audio Board, reverse the procedure.

maintenance & service guide

Presario 1400 Series

Model XL240, XL241, XL242, XL244, XL245, XL246, XL247, XL250, XL340, XL341, XL342, XL343, XL344, XL345, XL346, XL350, XL352, XL355, and XL356

Speaker Assembly

To remove the Speaker Assembly, complete the following steps:

1. Prepare the Notebook for disassembly ([pg 4](#)).
2. Remove the cosmetic side covers ([pg 7](#)).
3. Remove the speaker port covers ([pg 8](#)).
4. Remove the Modem/Memory Access Door ([pg 9](#)).
5. Remove the Internet Button Board cover ([pg 23](#)).
6. Remove the keyboard ([pg 25](#)).
7. Remove the PCA Button Board ([pg 26](#)).
8. Remove the display panel assembly ([pg 28](#)).
9. Remove the MP3 Zone Cover ([pg 29](#)).
10. Remove the Heatspreader ([pg 30](#)).
11. Remove the Palmrest Cover with TouchPad, Upper CPU, ([pg 32](#)).
12. Remove the MP3 audio board ([pg 36](#)).

[Continued](#)

maintenance & service guide

Presario 1400 Series

Model XL240, XL241, XL242, XL244, XL245, XL246, XL247, XL250, XL340, XL341, XL342, XL343, XL344, XL345, XL346, XL350, XL352, XL355, and XL356

13. Lift and remove the Speaker Assembly from the chassis.

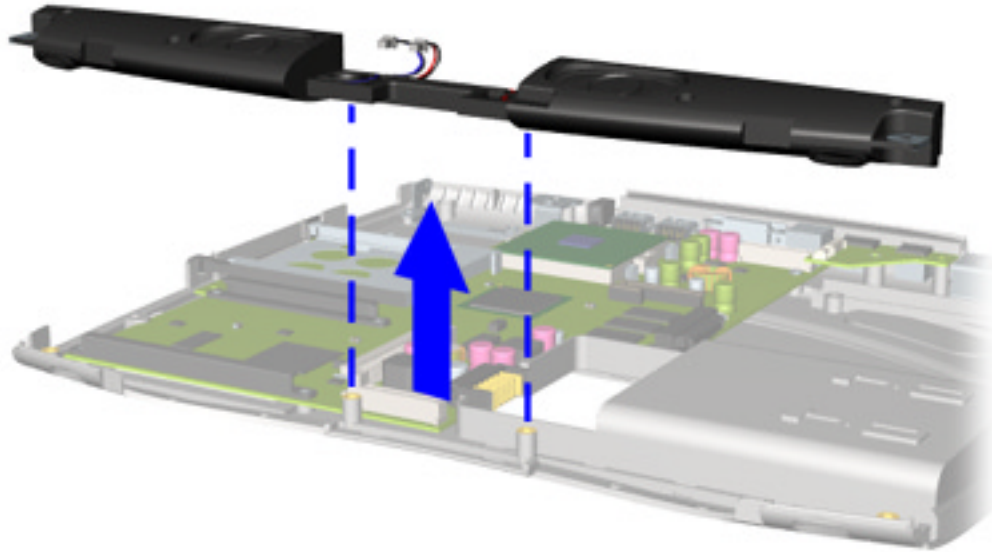

To replace the Speaker Assembly, reverse the procedure.

maintenance & service guide

Presario 1400 Series

Model XL240, XL241, XL242, XL244, XL245, XL246, XL247, XL250, XL340, XL341, XL342, XL343, XL344, XL345, XL346, XL350, XL352, XL355, and XL356

System Board

To remove the system board, complete the following steps:

1. Prepare the Notebook for disassembly ([pg 4](#)).
2. Remove the cosmetic side covers ([pg 7](#)).
3. Remove the speaker port covers ([pg 8](#)).
4. Remove the modem/memory access door ([pg 9](#)).
5. Remove the CD drive ([pg 12](#)).
6. Remove the hard drive ([pg 14](#)).
7. Remove the Internet Button Board cover ([pg 23](#)).
8. Remove the keyboard ([pg 25](#)).
9. Remove the PCA Button Board ([pg 26](#)).
10. Remove the display panel assembly ([pg 28](#)).
11. Remove the MP3 Zone Cover ([pg 29](#)).
12. Remove the heatspreader ([pg 30](#)).
13. Remove the Palmrest Cover with TouchPad, Upper CPU, ([pg 32](#)).
14. Remove the NIC cable ([pg 34](#)).
15. Remove the MP3 audio board ([pg 36](#)).
16. Remove the Speaker Assembly ([pg 38](#)).

[Continued](#)

maintenance & service guide

Presario 1400 Series

Model XL240, XL241, XL242, XL244, XL245, XL246, XL247, XL250, XL340, XL341, XL342, XL343, XL344, XL345, XL346, XL350, XL352, XL355, and XL356

17. Remove four screws ① from two Hard Drive Rails.
18. Remove both Hard Drive Rails ② from the system board.

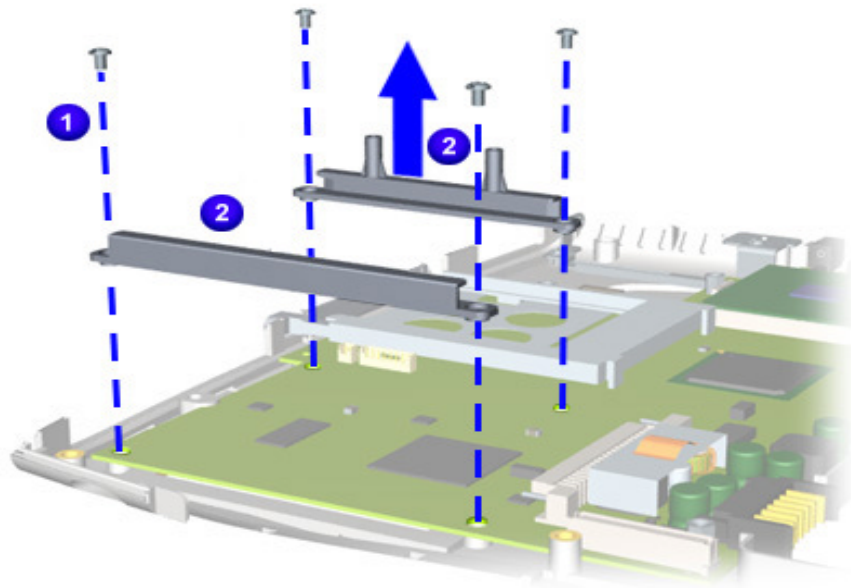

[Continued](#)

maintenance & service guide

Presario 1400 Series

Model XL240, XL241, XL242, XL244, XL245, XL246, XL247, XL250, XL340, XL341, XL342, XL343, XL344, XL345, XL346, XL350, XL352, XL355, and XL356

19. Remove six 5mm standoffs ❶ from system board.

20. Lift system board ❷ from chassis.

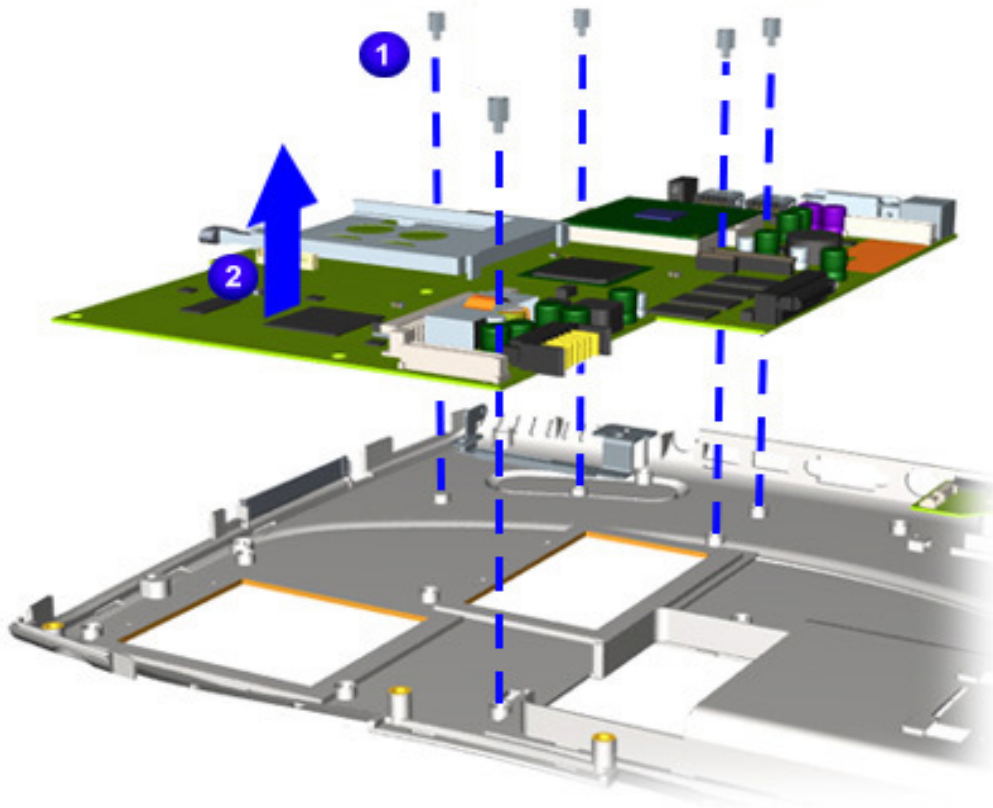

Note: Illustrations may show a fewer number of standoffs removed. It is necessary to remove only the parts listed in the written procedure.

To replace the system board, reverse the procedure.

maintenance & service guide

Presario 1400 Series

Model XL240, XL241, XL242, XL244, XL245, XL246, XL247, XL250, XL340, XL341, XL342, XL343, XL344, XL345, XL346, XL350, XL352, XL355, and XL356

Processor

To remove the processor, complete the following steps:

1. Prepare the Notebook for disassembly ([pg 4](#)).
2. Remove the cosmetic side covers ([pg 7](#)).
3. Remove the Internet Button Board cover ([pg 23](#)).
4. Remove the PCA Button Board ([pg 26](#)).
5. Remove the keyboard ([pg 25](#)).
6. Remove MP3 Zone Cover ([pg 29](#)).
7. Remove the heatspreader ([pg 30](#)).
8. Remove the Palmrest Cover with TouchPad, Upper CPU, ([pg 32](#)).

[Continued](#)

maintenance & service guide

Presario 1400 Series

Model XL240, XL241, XL242, XL244, XL245, XL246, XL247, XL250, XL340, XL341, XL342, XL343, XL344, XL345, XL346, XL350, XL352, XL355, and XL356

9. Shift with the flat end of screwdriver to the side in the slot ❶ that reads "OPEN" to unlock the processor.
10. Lift the processor ❷ from the chassis.

Note: The bottom of the processor contains socket pins that can be easily damaged if not properly removed or installed.

 **WARNING:** The processor may become very hot after the unit has been operating. Allow the processor time to cool before handling it.

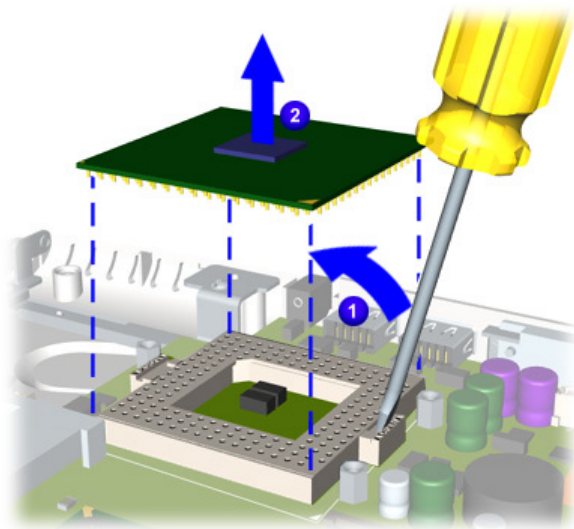

To replace the processor, refer to [Replacing the Processor](#).

Presario 1400 Series

Model XL240, XL241, XL242, XL244, XL245, XL246, XL247, XL250, XL340, XL341, XL342, XL343, XL344, XL345, XL346, XL350, XL352, XL355, and XL356

Replacing the Processor

To replace the processor, complete the following procedure:

1. Place the processor ② on the connectors correctly aligning the gold triangle with the silver triangle ③.
2. Shift with the flat end of a screwdriver, to the side in the slot ① that reads "CLOSED" to lock the processor.

Note: The bottom of the processor contains socket pins that can be easily damaged if not properly removed or installed.

⚠ WARNING: The processor may become very hot after the unit has been operating. Allow the processor time to cool before handling it.

